

3) Install the Tension Device

The tension device reduces the hazards of strangulation and entanglement of young children and pets by limiting access to the control cord. Anchor the tension device that is attached to the shade's control cord to the window frame or wall so that young children or pets cannot pull the cord around their necks.

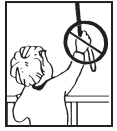

- a. Lower the shade.
- b. Hold the tension device upright so the Warning Tag hangs straight down as shown in diagram.
- c. Position the tension device on the window frame or the wall so that the tension device and control cord do not interfere with raising or lowering the shade. **The tension device should be installed without stretching or pulling down on the control cord. Stretching the cord will cause excessive wear. Do not twist or cross the control cord.** If using stop balls, position the tension device 1/4" higher to allow the stop ball to pass thru the tension device.
- d. Holding the tension device upright and in position as shown, insert and secure the screw through the hole. **The mounting screw must be secured into a solid surface or molly.**

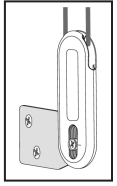

4) Operate the Shade

Operate the shade by pulling down on one side of the cord - one side of the cord raises the shade, the other side lowers the shade. Do not lift the bottom rail with your hands. Also, be careful not to place objects on the window sill that will interfere with operating the shade or cause it to hang unevenly.

5) To Remove a Shade

To remove a shade, from the bottom rear of the headrail, insert a flathead screwdriver in between the headrail and bracket. Gently twist the screwdriver and pry open the bracket to release the headrail. As you release the brackets, support the headrail to keep it from falling.

ROLLER SHADES

Clutch Assist/Clutch Free Installation Instructions - Sept 2009

1) Mount the Bracketrail

The shade will come pre-installed on the white bracketrail system. If the clutch is on the left end of the shade, reverse the bracket positions, left for right. Attach either the pin-end, screw adjust bracket, or wheel adjust bracket to the other side.

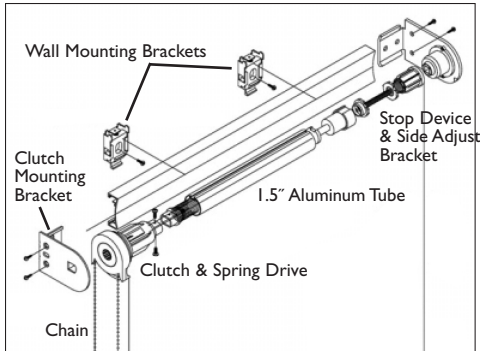

Clutch Assist Diagram

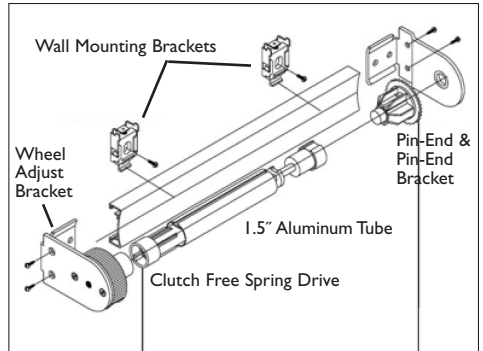

Clutch Free Diagram

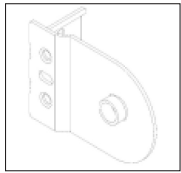

Pin-End Mounting Bracket

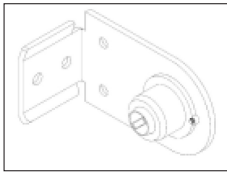

Side Adjust Mounting Bracket

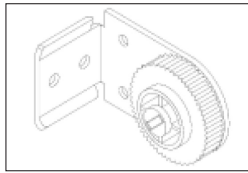

Wheel Adjust Mounting Bracket

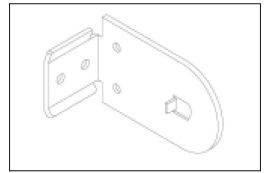

Clutch Mounting Bracket

2) Mount the Wall Brackets

This system utilizes wall brackets provided (pictured right). Mount the wall brackets evenly spaced and approximately 1/2" above the opening on the window frame, window molding, wall, or ceiling by drilling the screw through the wall bracket hole provided.

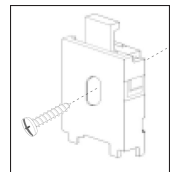

Wall Mounting Bracket

Cassette System Installation

1) Mount the Brackets

Mount the brackets to the wall or window frame, with the outside brackets no further than 2" (5 cm) from the ends of the headrail. On wide shades, space the additional bracket(s) at equal intervals.

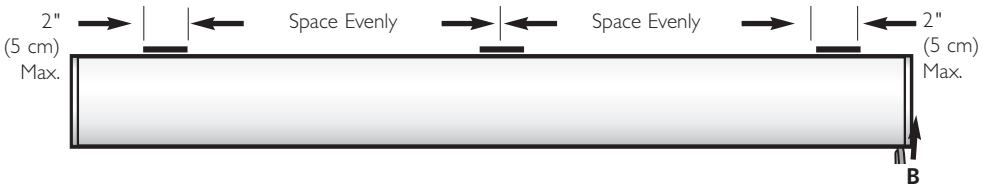

For wall or outside mounts, use the rear bracket holes.

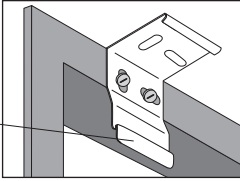

Make sure the release tab is always mounted on the bottom.

For inside or ceiling mounts, use the top bracket holes.

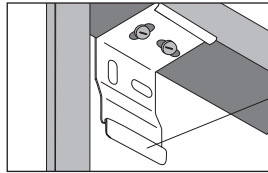

Make sure the release tab is always mounted on the bottom.

2) Mount the Headrail

Position the headrail with the front panel (A) resting on the top lip of all brackets. Push the bottom front of the headrail firmly backwards and toward the window until the lip on the rear of the headrail engages the bracket and snaps into place, (B) as shown.

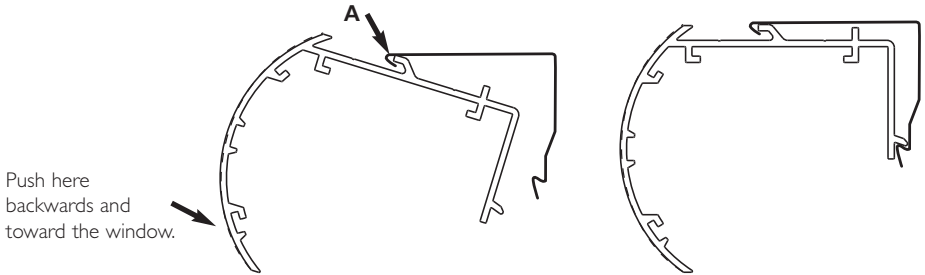

Push here backwards and toward the window.

3) Install the Shade

Attach the bracketrail system to the wall brackets by holding the bottom lip of the bracketrail system up to the bottom of the wall bracket that is already mounted on the wall. While holding the bottom of the bracketrail system in place, gradually bring up the top lip of the bracketrail system to the top of the wall bracket. Press firmly until you hear an audible click.



First hold the bracketrail system in place with the bottom lip on the bottom of the wall bracket.



Press the top of the bracketrail system onto the top of the wall bracket until you hear an audible click.

4) Install the Tension Device

The tension device reduces the hazards of strangulation and entanglement of young children and pets by limiting access to the control cord. Anchor the tension device that is attached to the shade's control cord to the window frame or wall so that young children or pets cannot pull the cord around their necks.



- a. Lower the shade.
- b. Hold the tension device upright so the Warning Tag hangs straight down as shown in diagram.
- c. Position the tension device on the window frame or the wall so that the tension device and control cord do not interfere with raising or lowering the shade. **The tension device should be installed without stretching or pulling down on the control cord. Stretching the cord will cause excessive wear. Do not twist or cross the control cord.** If using stop balls, position the tension device $\frac{1}{4}$ " higher to allow the stop ball to pass thru the tension device.
- d. Holding the tension device upright and in position as shown, insert and secure the screw through the hole. **The mounting screw must be secured into a solid surface or molly.**

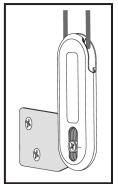

5) Use the Control Cord to Operate the Shade

Pulling gently on the cord in one direction lowers the shade; pulling it once raises it.

On shades where the fabric rolls against the window, the front cord, pulled once, does the raising. On shades where the fabric rolls toward the room, the rear cord, pulled once, does the raising.