

# PLEATED SHADES

## Product Information Guide

### Features

Fabric Styles and Information . . . . .	3
Light Control and Privacy Levels . . . . .	3
Oeko-Tex® Standard 100 Certified Fabrics . . . . .	3
Summary . . . . .	4

### Control Type and Size Considerations

Cordless Lift . . . . .	5-6
Bottom Up/Top Down Cordless Lift . . . . .	7
Sun Up/Sun Down Cordless Lift . . . . .	7
Continuous-Loop Lift Shades . . . . .	8-10
Combination Shade Cordless Lift . . . . .	11-12

### Options

Shade Liner . . . . .	13
Motorized Lift . . . . .	13
Multiple Shades On One Headrail . . . . .	14
Corner Windows . . . . .	15
Bay Windows . . . . .	16
Specialty Shapes: Arch Shades . . . . .	17
Specialty Shapes: Angle Top . . . . .	18
SkyTrack™ Skylight . . . . .	18
Enhanced Light Control Features . . . . .	19
Making a Template for Specialty Windows . . . . .	20
Using Template Service . . . . .	20

### General Information

Stack Height Chart . . . . .	21
Stack Height Chart: Combination Shade . . . . .	22
Pleated Shade Color Coordination Chart . . . . .	23
Cordless Lift Product Detail . . . . .	24
Continuous-Loop Lift Product Detail . . . . .	25
Bottom Up/Top Down: Cordless Lift Product Detail . . . . .	26
Combination Shade Cordless Lift Product Detail . . . . .	27



## Features

Bali® Pleated Shades include a variety of prints and elegant weaves in fashionable colors. The unique design of the back ladder support of Neat Pleat® ensures that pleats will not sag or flatten. These classic shades are an elegant addition to any window and match easily with other window treatments.

- Neat Pleat back ladder support gives pleats an even, dimensional appearance
- Many fashion-inspired patterns, colors, and textures enhance any room
- Color coordinated rails and components
- Offer numerous light control and privacy levels
- Two liners offered for light control: light filtering and room darkening
- Two pleat sizes offered: 1" and 2" pleat (select styles)

Features	Benefits
<b>Neat Pleat Shades</b>	
Neat Pleat Loop Tape	<ul style="list-style-type: none"> <li>• Ensures consistent pleat spacing from top to bottom for a perfect, tailored look; pleats won't sag</li> <li>• Patterns remain uniform throughout the shade</li> <li>• No need to periodically raise the shade</li> </ul>
Many Fabric Styles from Which to Choose, Including a Variety of Textures, Colors, and Patterns	<ul style="list-style-type: none"> <li>• Great design flexibility</li> <li>• Something to suit everyone's taste and budget</li> <li>• Fresh color offerings in tune with today's decor trends</li> <li>• 2" pleat is an ideal solution for larger windows</li> </ul>
Limited Lifetime Warranty	<ul style="list-style-type: none"> <li>• Guarantees years of trouble-free shade operation</li> </ul>
<b>Standard Pleat Shades</b>	
Many Fabric Styles from Which to Choose	<ul style="list-style-type: none"> <li>• Great design flexibility</li> <li>• Something to suit everyone's taste and budget</li> </ul>
Three-Year Warranty	<ul style="list-style-type: none"> <li>• Guarantees trouble-free shade operation</li> <li>• Product is warranted against original defects in materials or workmanship</li> </ul>
<b>Pleated Shades</b>	
Aluminum Headrail System	<ul style="list-style-type: none"> <li>• Strong, yet lightweight</li> <li>• Color coordinated to fabric</li> <li>• Extremely durable</li> <li>• Rail color coordination can be specified at the time of purchase</li> </ul>
Two Different Fabric Liners Available	<ul style="list-style-type: none"> <li>• Changes privacy level of any fabric to either light filtering or room darkening</li> <li>• Provides neutral exterior appearance regardless of interior color</li> <li>• Available with select 1" or 2" fabrics</li> </ul>
Cordless Lift	<ul style="list-style-type: none"> <li>• Eliminates external lift cord loops</li> <li>• Available on select fabrics</li> </ul>
Continuous-Loop Lift	<ul style="list-style-type: none"> <li>• Cord loop raises and lowers the shade; adjust large and hard-to-operate shades more easily</li> <li>• Helps lift large, heavy shades</li> <li>• Sleek, low profile; color coordinated headrail is sturdy aluminum</li> </ul>
Variety of Specialty Shades Available	<ul style="list-style-type: none"> <li>• Coordinated hard-to-cover specialty windows for total room decor</li> <li>• Provides light control</li> </ul>
Motorized Lift	<ul style="list-style-type: none"> <li>• Provides easy operation of hard-to-reach or large windows</li> <li>• Eliminates external lift cord loops</li> <li>• Available with all fabrics</li> </ul>

## Features

### Fabric Styles and Information

Fabric Styles	1" Standard Pleat	1" Neat Pleat®	2" Neat Pleat	Fabric Content	Fabric Width (inches)	Privacy Rating	Liner Available	Overlap*	Cordless Lift Available	Oeko-Tex Certified Fabrics
Day Liner		•	•	100% polyester	72	Light filtering		•	•	
Domain		•	•	100% polyester	94	Light filtering	•		•	•
Dundee		•	•	100% polyester	92	Light filtering	•	•	•	•
Dunes	•	•	•	100% polyester	94	Light filtering	•	•	•	•
Footpath			•	100% polyester	94	Light filtering	•		•	•
Fractured		•		100% polyester	92	Light filtering	•		•	•
Gabardine		•	•	92.6% polyester 4.3% cotton strap 3.1% flax	94	Light filtering	•		•	•
Gauze			•	100% polyester	94	Light filtering	•	•	•	•
Intuition		•	•	100% polyester	92	Sheer		•	•	
Luminance	•	•		100% polyester	72	Light filtering	•	•	•	
Midnight Liner		•	•	100% polyester	72	Room darkening		•		
Mountainside			•	100% polyester	92	Light filtering	•	•	•	•
Ornamental			•	100% polyester	94	Light filtering	•		•	•
Shoreline			•	100% polyester	72	Light filtering	•		•	•
Springleaf		•		100% polyester	92	Light filtering	•		•	•
Westport	•	•	•	100% polyester	72	Sheer		•	•	

\*Overlap are not available with bottom up/top down, sun up/sun down, combination shade, and multiple shades on one headrail.

### Light Control and Privacy Levels

**Sheer:** Allows the most sunlight and least privacy

**Light Filtering:** Blocks some sunlight and offers some privacy

**Day Liner:** Offers increased light control and privacy. At night, objects in your home will appear as silhouettes from the outside.

**Midnight Liner:** Blocks light and offers complete privacy. At night, objects in your home will not be seen from the outside.

### Oeko-Tex® Standard 100 Certified Fabrics

Fabric styles Domain, Dundee, Dunes, Footpath, Fractured, Mountainside, Gabardine, Gauze, Ornamental, Shoreline, and Springleaf are Oeko-Tex Standard 100 Certified and are free of PVC, halogen, lead, formaldehyde, allergenic dyes, pesticides, phenols, heavy metals, and meet all VOC content limits.

Oeko-Tex is a registered trademark of the Oeko-Tex Association.



# Features

## Summary (for surcharges and pricing refer to price charts)

The following is a list of options for pleated shades. Most options are available in all styles and colors. Limitations will be based on fabric width and fabric type. See detailed descriptions on the following pages.

### Control Type Options (see price charts for pricing and/or surcharges)

- Continuous-loop lift
- Cordless lift
- Motorized lift (see motorization product information guide)

### Shade Options—No Charge

- Cord loop placement on right or left
- Custom cord loop length is available upon request at time of order
- Corner or bay window
- Hold down brackets
- Projection brackets
  - With 1" and 2" pleated shades (cordless lift, continuous-loop lift, and motorized lift)
    - Long (adds up to 2½" extension from wall)
    - Medium (adds up to 1⅝" extension from wall)
    - Short (adds up to 1" extension from wall)
  - With 2" Neat Pleat®
    - Long (adds up to 2¼" extension from wall)
    - Medium (adds up to 1⅜" extension from wall)
    - Short (adds up to ¾" extension from wall)
- Rail color can be specified at the time of order
- Shims
- Side-mount brackets: inside mount only

### Specialty Shape Shade Options (see price charts for pricing and/or surcharges)

- Angled top
- Arches



### Shade Options—Surcharge (see price charts for pricing and/or surcharges)

- Room-darkening side channels: 2" pleated; cordless lift, and motorized control
- Bottom up/top down: cordless lift
- Liners
- Multiple shades on one headrail
- Combination shade: cordless lift
- Sky pole
- Skylight shades
- Sun up/sun down: cordless lift

### Control Type

Pleat Size	Cordless Lift	Continuous-Loop Lift	Motorized Lift	Bottom Up/Top Down	Sun Up/Sun Down	Combination	Side Channels	Sky Track	Arches	Angle Top
1"	•	•	•	•	•	•			•	•
2"	•	•	•	•	•	•	•	•	•	

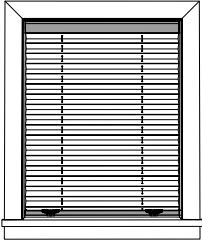
## Control Type and Size Considerations

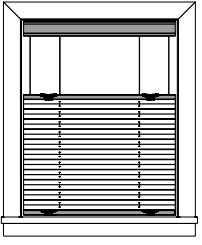
<b>Cordless Lift</b>																
Fabric Styles	Fabric Width (inches)	Overlap Available	Liner Available													
				Cordless Lift (inches)				Cordless Lift Multiple Shades on One Headrail (inches)					Cordless Lift Bottom Up/Top Down (inches)			
				Width		Height		Width			Height		Width		Height	
				Min†	Max	Min	Max	Min Panel†	Max Panel	Max Shade	Min Shade	Max Shade	Min†	Max	Min	Max
<b>1" Standard Pleat</b>																
Dunes	94	•	•	12	96	9	86	12	94	144	9	86	15	84	9	86
Luminance	72	•	•	12	96	9	86	12	72	144	9	86	15	72	9	86
Westport	72	•	•	12	96	9	86	12	72	144	9	86	15	72	9	86
<b>1" Neat Pleat®</b>																
Day Liner	72	•	•	12	96	6	86	12	72	120	6	86	15	72	9	86
Domain	94	•	•	12	94	6	86	12	94	120	6	86	15	84	9	86
Dundee	92	•	•	12	96	6	86	12	92	120	6	86	15	84	9	86
Dunes	94	•	•	12	96	6	86	12	94	120	6	86	15	84	9	86
Fractured	92	•	•	12	92	6	86	12	92	120	6	86	15	84	9	86
Gabardine	94	•	•	12	94	6	86	12	94	120	6	86	15	84	9	86
Intuition	92	•	•	12	96	6	86	12	92	120	6	86	15	84	9	86
Luminance	72	•	•	12	96	6	86	12	72	120	6	86	15	72	9	86
Springleaf	92	•	•	12	92	6	86	12	92	120	6	86	15	84	9	86
Westport	72	•	•	12	96	6	86	12	72	120	6	86	15	72	9	86
<b>2" Neat Pleat</b>																
Day Liner	72	•	•	12	96	12	86	12	72	144	12	86	15	72	12	86
Domain	94	•	•	12	94	12	86	12	94	144	12	86	15	84	12	86
Dundee	92	•	•	12	96	12	86	12	92	144	12	86	15	84	12	86
Dunes	94	•	•	12	96	12	86	12	94	144	12	86	15	84	12	86
Footpath	94	•	•	12	94	12	86	12	94	144	12	86	15	84	12	86
Gabardine	94	•	•	12	94	12	86	12	94	144	12	86	15	84	12	86
Gauze	94	•	•	12	96	12	86	12	94	144	12	86	15	84	12	86
Intuition	92	•	•	12	96	12	86	12	92	144	12	86	15	84	12	86
Mountainside	92	•	•	12	96	12	86	12	92	144	12	86	15	84	12	86
Ornamental	94	•	•	12	94	12	86	12	94	144	12	86	15	84	12	86
Shoreline	72	•	•	12	72	12	86	12	72	144	12	86	15	72	12	86
Westport	72	•	•	12	96	12	86	12	72	144	12	86	15	72	12	86

†For all inside mount applications, 3/8" deduction is taken by manufacturer on overall width.

**NOTE:** Cordless lift maximum overall area for 1" Gabardine is 5400 square inches, 1" Domain, Dundee, and Dunes is 6400 square inches, 1" Intuition is 7000 square inches; 2" Footpath is 4000 square inches, 2" Domain, Dundee, Gabardine, Gauze, and Ornamental is 4800 square inches, 2" Dunes, Intuition, and Mountainside is 6000 square inches, 2" Westport is 7400 square inches. Maximum width and height for shades with side channels is 120".

## Control Type and Size Considerations

### Depth Requirements for Inside Mount

Shade Type	Headrail Dimensions (Inches)	Minimum Depth Mount (inches)	Flush with Casing (Inches)
1" Pleat	1 <sup>7</sup> / <sub>16</sub> x 2 <sup>1</sup> / <sub>8</sub>	5 <sup>5</sup> / <sub>8</sub>	2 <sup>3</sup> / <sub>8</sub>
2" Pleat	1 <sup>7</sup> / <sub>16</sub> x 2 <sup>3</sup> / <sub>8</sub>	5 <sup>5</sup> / <sub>8</sub>	2 <sup>3</sup> / <sub>8</sub>

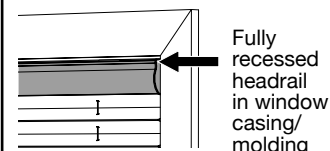
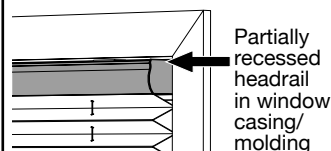

### Cordless Lift

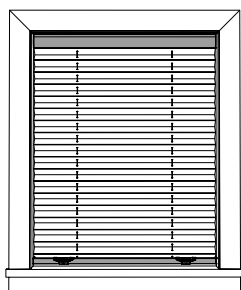

- **For surcharge, see price charts**
- Available with the day liner option on single panels of fabric (no overlap)
- Cordless lift shades are the safest window shade alternative; ideal for homes with children and pets
- Overlap not available with Domain, Footpath, Fractured, Gabardine, Ornamental, Shoreline, or Springleaf
- Cordless lift shades should only be used on windows where consumers can comfortably raise and lower the shade with their hand
- Room-darkening side channels are available:
  - Surcharge (see price charts)
  - 2" pleated only
  - Side channels are Canyon Gray 053, Cream 715, Creamy Pearl 356, Revere Pewter 190, Sable 565, Smokey Gray 026, or White Satin 205
- Sky poles are not recommended; however, if required, two sky poles should be ordered to ensure even operation

Size Considerations	Minimum Width* (Inches)	Maximum Width† (Inches)	Minimum Height (Inches)	Maximum Height (Inches)
1" Standard Pleat	12	96	9	86
1" Neat Pleat®	12	96	6	86
2" Neat Pleat	12	96	12	86

\*For all inside mount applications, 3/8" deduction is taken by manufacturer on overall width.

†Based on fabric width with overlap.

**NOTE:** Cordless lift maximum overall area for 1" Gabardine is 5400 square inches, 1" Domain, Dundee, and Dunes is 6400 square inches, 1" Intuition is 7000 square inches; 2" Footpath is 4000 square inches, 2" Domain, Dundee, Gabardine, Gauze, and Ornamental is 4800 square inches, 2" Dunes, Intuition, and Mountainside is 6000 square inches, 2" Westport is 7400 square inches.

## Control Type and Size Considerations

### Bottom Up/Top Down Cordless Lift

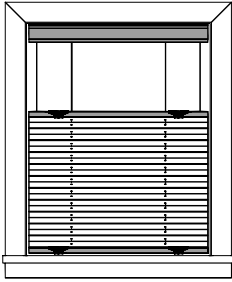

- **For surcharge, see price charts**
- Option allows for privacy; lets in natural light
- Cordless lift shades are the safest window shade alternative; ideal for homes with children and pets
- Overlap not available
- Suggested use on windows where consumers can comfortably raise and lower the shade with their hand
- Sky poles are not recommended; however, if required, two sky poles should be ordered to ensure even operation

Size Considerations	Minimum Width* (inches)	Maximum Width† (inches)	Minimum Height (inches)	Maximum Height (inches)
1" Standard Pleat	15	84	9	86
1" Neat Pleat®	15	84	9	86
2" Neat Pleat	15	84	12	86

\*For all inside mount applications, 3/8" deduction is taken by manufacturer on overall width.

†Not available with overlap.

Maximum width and height for shades with side channels is 120".

**NOTE:** See cordless area limit chart for fabric-specific limitations.

### Sun Up/Sun Down Cordless Lift

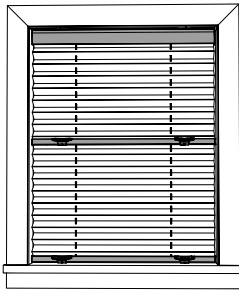

- Perfect for combining light controls of sheer or light-filtering fabrics
- Available with 1" or 2" pleated fabrics
- Cannot combine 1" and 2" pleat sizes
- Headrail coordinates with top fabric, bottomrail coordinates with bottom fabric, and midrail will match headrail as a default
- Overlap not available
- Cordless lift shades are the safest window shade alternative; ideal for homes with children and pets
- Cordless lift shades should only be used on windows where consumers can comfortably raise and lower the shade with their hand
- Sky poles are not recommended; however, if required, two sky poles should be ordered to ensure even operation

Size Considerations	Minimum Width* (inches)	Maximum Width† (inches)	Minimum Height (inches)	Maximum Height (inches)
1" Pleated	15	84	12	86
2" Pleated	15	84	12	86

\*For all inside mount applications, 3/8" deduction is taken by manufacturer on overall width.



†Based on fabric width; narrowest of the two fabrics is the maximum width.

Maximum width and height for shades with side channels is 120".

**NOTE:** See cordless area limit chart for fabric-specific limitations.

## Control Type and Size Considerations

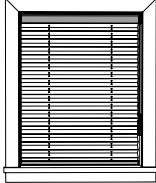
### Continuous-Loop Lift Shades

Fabric Styles	Fabric Width (inches)	Overlap Available Liner Available											
				Continuous-Loop Lift (inches)				Continuous-Loop Lift Multiple Shades on One Headrail (inches)					
				Width		Height		Width			Height		
				Min†	Max	Min	Max	Min Panel†	Max Panel	Max Shade Single Control	Max Shade Multiple Controls	Min Shade	Max Shade
<b>1" Standard Pleat</b>													
Dunes	94	•	•	18 1/2	120	9	96	18 1/2	94	120	144	9	96
Luminance	72	•	•	18 1/2	120	9	96	18 1/2	72	120	144	9	96
Westport	72	•	•	18 1/2	120	9	96	18 1/2	72	120	144	9	96
<b>1" Neat Pleat®</b>													
Day Liner	72	•	•	18 1/2	120	6	96	18 1/2	72	120	120	6	96
Domain	94	•	•	18 1/2	94	6	96	18 1/2	94	120	120	6	96
Dundee	92	•	•	18 1/2	120	6	96	18 1/2	92	120	120	6	96
Dunes	94	•	•	18 1/2	120	6	96	18 1/2	94	120	120	6	96
Fractured	92	•	•	18 1/2	92	6	96	18 1/2	92	120	120	6	96
Gabardine	94	•	•	18 1/2	94	6	96	18 1/2	94	120	120	6	96
Intuition	92	•	•	18 1/2	120	6	96	18 1/2	92	120	120	6	96
Luminance	72	•	•	18 1/2	120	6	96	18 1/2	72	120	120	6	96
Springleaf	92	•	•	18 1/2	92	6	96	18 1/2	92	120	120	6	96
Westport	72	•	•	18 1/2	120	6	96	18 1/2	72	120	120	6	96
<b>2" Neat Pleat</b>													
Day Liner	72	•	•	18 1/2 ‡	144	12	120 **	18 1/2	72	144	144	12	120
Domain	94	•	•	18 1/2 ‡	94	12	120 **	18 1/2	94	144	144	12	120
Dundee	92	•	•	18 1/2 ‡	144	12	120 **	18 1/2	92	144	144	12	120
Dunes	94	•	•	18 1/2 ‡	144	12	120 **	18 1/2	94	144	144	12	120
Footpath	94	•	•	18 1/2 ‡	94	12	120 **	18 1/2	94	144	144	12	120
Gabardine	94	•	•	18 1/2 ‡	94	12	120 **	18 1/2	94	144	144	12	120
Gauze	94	•	•	18 1/2 ‡	144	12	120 **	18 1/2	94	144	144	12	120
Intuition	92	•	•	18 1/2 ‡	144	12	120 **	18 1/2	92	144	144	12	120
Mountainside	92	•	•	18 1/2 ‡	144	12	120 **	18 1/2	92	144	144	12	120
Ornamental	94	•	•	18 1/2 ‡	94	12	120 **	18 1/2	94	144	144	12	120
Shoreline	72	•	•	18 1/2 ‡	72	12	120 **	18 1/2	72	144	144	12	120
Westport	72	•	•	18 1/2 ‡	144	12	120 **	18 1/2	72	144	144	12	120

†For all inside mount applications, 3/8" deduction is taken by manufacturer on overall width.

\*\*Height limited to 96" with overlap.

**NOTE:** Please refer to area limit chart for size restrictions by fabric.

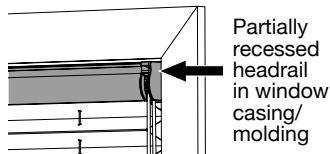
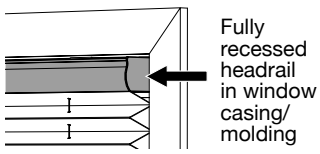

## Control Type and Size Considerations

<b>Depth Requirements for Inside Mount Continuous-Loop Lift</b>			
<b>Shade Type</b>	<b>Headrail Dimensions (inches)</b>	 <p style="text-align: center; margin-top: 5px;"><b>Minimum Depth Mount (inches)</b></p>	 <p style="text-align: center; margin-top: 5px;"><b>Flush with Casing (inches)</b></p>
1" Pleat	1 <sup>7</sup> / <sub>16</sub> x 2 <sup>1</sup> / <sub>8</sub>	5/ <sub>8</sub>	2 <sup>3</sup> / <sub>8</sub>
2" Pleat	1 <sup>7</sup> / <sub>16</sub> x 2 <sup>7</sup> / <sub>16</sub>	5/ <sub>8</sub>	2 <sup>3</sup> / <sub>8</sub>

## Control Type and Size Considerations

### Continuous-Loop Lift

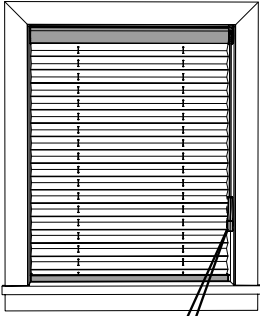

- For surcharges, see price charts
- Recommended for larger, heavier shades
- Larger shades use a geared clutch for easier lifting, but additional pulls are required to lift the shade
- A single continuous-loop cord raises and lowers the shade and keeps the cord the same length
- Safety locking cord guide included; cord guide must be installed for shade operation

**NOTE:** When ordered as multiple shades on one headrail, there can be either one or two controls. A single control on the left or right can be used on shades up to 120" wide to operate all panels. With two controls, the left control operates the left panel and the right control operates the right panel. For three panel shades, specify middle panel as control right or control left. Continuous-loop controls cannot be located in the middle of a headrail.

Size Considerations	Minimum Width* (inches)	Maximum Width† (inches)	Minimum Height (inches)	Maximum Height (inches)
1" Standard Pleat	18½	120	9	96
1" Neat Pleat®	18½	120	6	96
2" Neat Pleat	18½	144	12	120**

\*For all inside mount applications, ¾" deduction is taken by manufacturer on overall width.

\*\*Height limited to 96" with overlap.

†Based on fabric width with overlap.

Loop Cord Colors	
Smokey Gray	026
Tender Taupe	103
Vanilla	100
White	00

Tension Device Colors	
Clear	00
White	871
Cream	715

Continuous-Loop Lift Control Area Limit Chart	
Fabric Style	Maximum Shade Size (square inches)
2" Domain, Dundee, Dunes, Footpath, Gabardine, Gauze, Intuition, Mountainside, Ornamental, Shoreline	9000
1" Domain, Dundee, Dunes, Gabardine, Intuition, Springleaf	11000
1" Fractured, Luminance, Westport; 2" Westport	13000
Liner only shades	17000

Control length for continuous-loop lift shades varies based on the finished shade height. Optional cord loop lengths are available and must be specified at the time of the order. The chart below lists the standard cord length.

Finished Shade Height	1" Pleated Continuous-Loop Cord Length (inches)	2" Pleated Continuous-Loop Cord Length (inches)
12 to 26	18	18
26⅙ to 38	24	24
38⅙ to 50	36	36
50⅙ to 62	48	48
62⅙ to 74	60	60
74⅙ to 96	72	72
96⅙ to 120	N/A	84

Optional cord lengths: 84", 96", and 108".

## Control Type and Size Considerations

### Combination Shade Cordless Lift

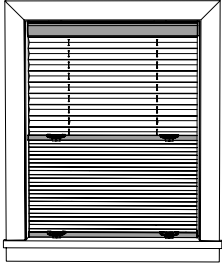
					
		<b>Cordless Lift All Cellular Fabric Styles (inches)</b>			
<b>Fabric Styles (inches)</b>	<b>Fabric Width (inches)</b>	<b>Width</b>		<b>Height</b>	
		<b>Minimum†</b>	<b>Maximum</b>	<b>Minimum</b>	<b>Maximum</b>
<b>1" Standard Pleat</b>					
Luminance Westport	72	15	72	12	86
Dunes	94	15	94	12	86
<b>1" Neat Pleat®</b>					
Luminance Westport	72	15	72	12	86
Dundee Fractured Intuition Springleaf	92	15	92	12	86
Domain Dunes Gabardine	94	15	94	12	86
<b>2" Neat Pleat</b>					
Shoreline Westport	72	15	72	12	86
Dundee Intuition Mountainside	92	15	92	12	86
Domain Dunes Footpath Gabardine Gauze Ornamental	94	15	94	12	86

†For all inside mount applications, 3/8" deduction is taken by manufacturer on overall width.

Maximum area for Hideaway 1/2" double cell is 6,400 square inches.

Maximum area for 1" Domain, Dundee, and Gabardine is 6400 square inches; 2" Footpath and Gabardine is 5800 square inches;

2" Ornamental is 7000 square inches, 2" Domain, Dundee, and Gauze is 7600 square inches.

## Control Type and Size Considerations

### Depth Requirements for Inside Mount

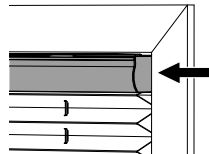
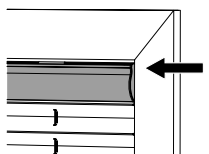
Shade Type	Cordless Lift Shades Headrail Dimensions (inches)	 Partially recessed headrail in window casing/ molding  Minimum Depth Mount (inches)	 Fully recessed headrail in window casing/ molding  Flush with Casing (inches)
1" Pleat	1 <sup>9</sup> / <sub>16</sub> x 2 <sup>7</sup> / <sub>8</sub>	5/8	2 <sup>7</sup> / <sub>8</sub>
2" Pleat	1 <sup>9</sup> / <sub>16</sub> x 2 <sup>3</sup> / <sub>8</sub>	5/8	2 <sup>7</sup> / <sub>8</sub>

### Combination Shade Cordless Lift

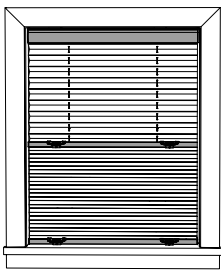

- **For pricing, see price charts**
- Perfect for combining light controls of sheer or light-filtering pleated fabric with blackout cellular fabrics
- Cordless lift shades are the safest window shade alternative; ideal for homes with children and pets
- 1" pleated can be combined with 9/16" single cell cellular fabrics only
- 2" pleated can be combined with 1/2" double cell or 3/4" single cell cellular fabrics only
- Headrail coordinates with pleated top fabric; bottomrail coordinates with bottom cellular fabric; midrail will match headrail as default; not available with multiple shades on one headrail
- All combination shade cordless lift shades should only be used on windows where consumers can comfortably raise and lower the shade with their hands and have easy access; operation of shade requires both sets of handles be used to properly raise and lower rails
- Sky poles not recommended; however, if required, two sky poles should be ordered to ensure even operation

Size Considerations		Minimum Width* (inches)	Maximum Width (inches)	Minimum Height (inches)	Maximum Height (inches)
1" Pleat	All fabric styles	15	94**	12	86
2" Pleat	All fabric styles	15	94**	12	86

\*For all inside mount applications, 3/8" deduction is taken by manufacturer on overall width.

\*\*Maximum single shade width is 94" or maximum fabric width, whichever is smaller.

**NOTE:** 1" Domain, Dundee, and Gabardine is 6400 square inches; 2" Footpath and Gabardine is 5800 square inches;

2" Ornamental is 7000 square inches, 2" Domain, Dundee, and Gauze is 7600 square inches.

# Options

## Shade Liner

- **For surcharge, see price charts**
- Available on select styles with continuous-loop, and motorized lift systems
- Day liner is available with cordless lift as a single panel only (no overlap)
- Creates neutral to the street side appearance
- Create room-darkening effects by adding a midnight liner
- Standard pleat day liner and midnight liner are not available as a shade alone
- Due to construction of shade, light will filter through the route holes even with a midnight liner

### Optional liners increase privacy and light control.

**Day liner:** Allows a small amount of light to enter the room for a greater sense of privacy. Inside objects appear as shadows.

**Midnight liner:** Prevents light from entering for a high level of light control with maximum privacy, preventing even silhouettes from showing through. Due to construction of the shade, light will filter through the route holes even with midnight liner.

**NOTE:** For shade widths greater than fabric width and heights up to 60", the liners will overlap at the same location as the fabric overlap. For shade widths greater than fabric width and heights over 60", the liners will overlap in the center of the shade. Maximum finished shade width limited to 142" for 1" fabrics and 140" for 2" fabrics.

## Motorized Lift



- **Refer to motorization product information guide for additional options, sizing, and pricing**
- Window treatments can be operated from virtually anywhere in the home
- Provides easy operation of hard-to-reach or large window coverings
- Efficiently manages energy (heat gain and loss)
- Operate multiple window treatments simultaneously or individually, up to 65 feet
- A safer window shade alternative; ideal for homes with children and pets
- Easily integrated with home automation systems and voice assistance
- Low voltage motorization requires no costly electrical hardwiring
- Multiple control and power options available
- Control your shades directly from your smartphone or tablet

**NOTE:** Motorization components and accessories have a five-year limited warranty, excluding batteries.



# Options

## Multiple Shades On One Headrail

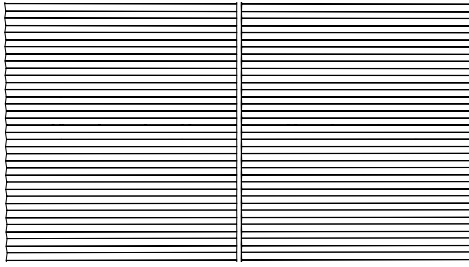

Gap

- Surcharge for two or three shades on one headrail less than or equal to fabric width (see price charts)
- Shade widths exceeding fabric width made as two or three shades on one headrail—no charge
- Side mounts available
  - Single shade width: 60"
  - Multiple shades on one headrail: 42"

Size Considerations		Maximum Overall Size for Multiple Shades* (inches)	Maximum Size with Side Mount (inches)	Control Locations	Gap (inches)
Continuous-Loop Lift Single Control	1" Standard Pleat	120 x 96	60 x 96	Two-on-one: Common lift cord can be on right or left to operate both shades at the same time Three-on-one: Common lift cord can be on right or left to operate all shades at the same time	1/2
	1" Neat Pleat	120 x 96			
	2" Neat Pleat	144 x 120			
Continuous-Loop Lift Multi Control	1" Standard Pleat	144 x 96	60 x 96	Two-on-one: Left shade, left control Right shade, right control Three-on-one: Left shade, left control Right shade, right control Middle shade, common lift cord to right or left shade. Continuous-loop lift system cannot be used in the middle of the headrail on multiple shades	1/2
	1" Neat Pleat	120 x 96			
	2" Neat Pleat	144 x 120			
Cordless Lift	1" Standard Pleat	144 x 86	60 x 96	Not applicable	3/8
	1" Neat Pleat	120 x 86			
	2" Neat Pleat	144 x 86			

\*See size considerations section for the minimum and maximum panel widths.  
Not available with motorization.

# Options

## Corner Windows

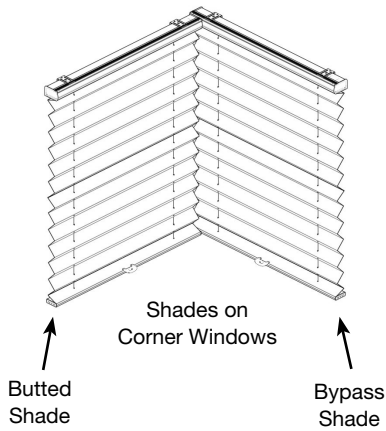

- **No charge**
- Made as individual shades
- Each shade will have its own control; we recommend opposite corners
- Indicate for each shade whether left or right and butt or bypass
- Bypass shade is mounted into the corner: butt shade is abutted to the other shade
- Manufacturer will take appropriate deductions for proper fit; **DO NOT** order as a corner shade if you do not want manufacturer to take deductions

### TOP VIEW

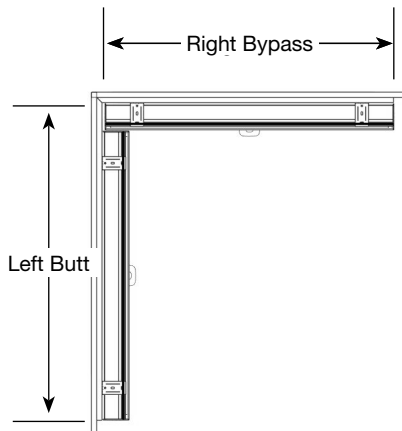

### Measuring Information

#### Mounting on a Wall or Molding:

Measure the width of each window from the corner on the mounting surface (molding or wall) to the point you would like to cover.

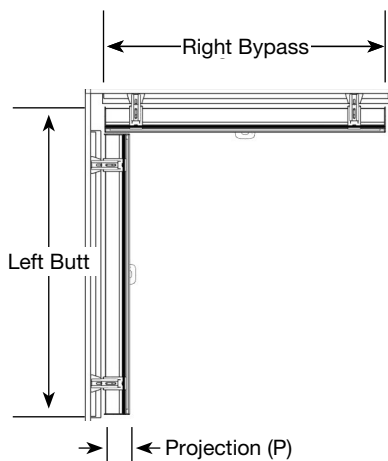

#### Mounting Above the Molding:

Measure the width of each window from the corner on the mounting surface to the point you would like to cover. Projection measurement is the distance needed to clear any molding or obstructions that the shade will be mounted above.

**NOTE:** The projection (P) distance is needed to correctly calculate deductions for installations where the shades will use shims or projection brackets to clear molding. All projection distances must match for correct deductions to be calculated.

# Options

## Bay Windows

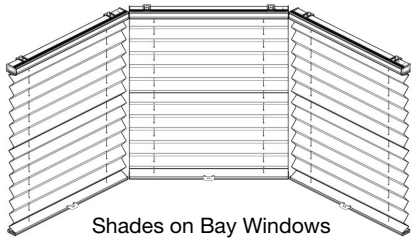

- **No charge**
- Made as individual shades
- Each section will have its own control
- Manufacturer will take appropriate deductions for proper fit; **DO NOT** order as bay window shade if you do not want manufacturing to take deductions

### Measuring Information: Three-Sided Bay Window

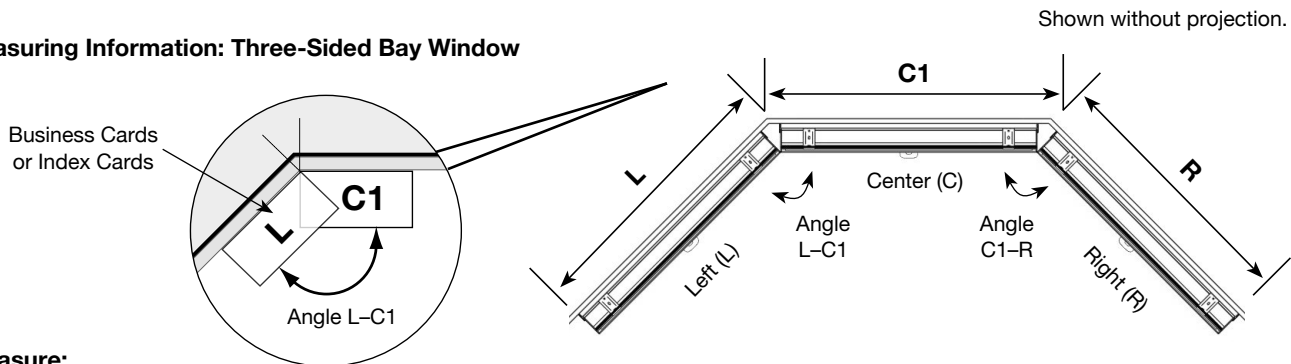

**Measure:**

- L and R:** Width of each side window from the corners on the mounting surface to the point you would like to cover.
- C1:** Width of the center window on the mounting surface from corner to corner.

- Angle L-C1:** Angle between the (L) and (C1) windows.
- Angle C1-R:** Angle between the (C1) and (R) windows.
- Projection:** If needed: The depth of the trim or molding the shade will be mounted above.

### Measuring Information: Four-Sided Bay Window

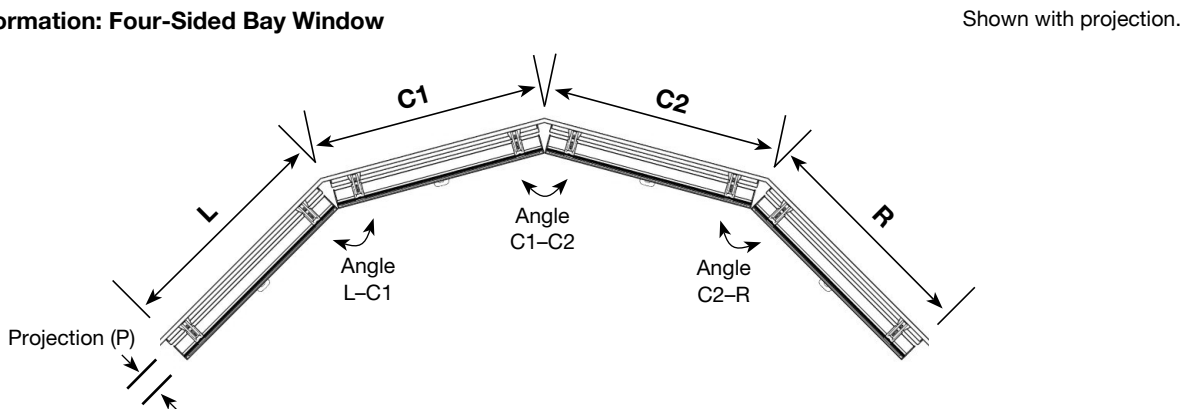

- L and R:** Width of each side window from the corners on the mounting surface to the point you would like to cover.
- C1, C2:** Width of each center window on the mounting surface from corner to corner.

- Angle L-C1:** Angle between the (L) and (C1) windows.
- Angle C1-C2:** Angle between the (C1) and (C2) windows.
- Angle C2-R:** Angle between the (C2) and (R) windows.
- Projection (P):** If needed: The depth of the trim or molding the shade will be mounted above.

**NOTE:** The projection (P) distance is needed to correctly calculate deductions for installations where the shades will use shims or projection brackets to clear trim or molding. All projection distances must match for correct deductions to be calculated. For additional windows on bays with up to five sides continue with number progression for center shade sizes (C1, C2, C3, ...) and angles (Angle C1-C2, Angle C2-C3, ...) as needed. Measure each bay angle using a protractor or angle finder or use two business cards in each bay corner as illustrated above, **trace on paper**, and fax to customer service. **The angle to use between adjacent center bay windows along a straight section of wall is 180° (degrees).**



# Options

## Specialty Shapes: Arch Shades

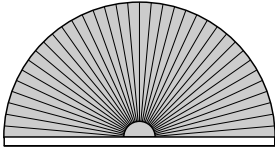

**Perfect Arch: Half Circle**

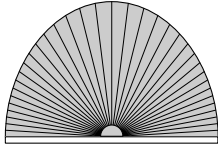

**Palladian**  
(template required)  
Illustration not to scale

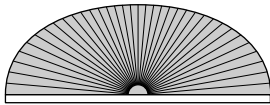

**Eyebrow Arch**  
(template required)

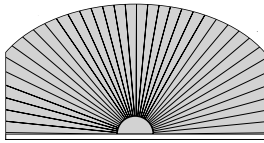

**Elongated Arch**  
(arch with straight sides)  
(template required)

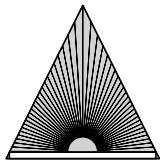

**Triangle**  
(template required)

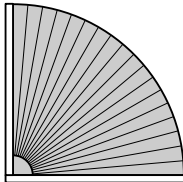

**Quarter Circle**  
(template not required  
if perfect quarter)

### Perfect Arches (template not required)

- **For surcharges, see price charts**
- Perfect arches are those where the radius of the circle is constant at all points; height is exactly half the width
- Perfect quarter circle is where height and width are equal
- For inside mount, measure inside of window frame; for outside mount, add the desired amount of overlap to your measurements
- Include width and height measurements on all orders
- Side mount available up to 60" wide exact
- Liner available if fabric allows

### Non-Perfect Arches (require a template)

- **For surcharges, see price charts**
- Non-perfect arches are those where the radius of the circle is NOT constant at all points; height is not exactly half the width
- Include width and height measurements on all orders
- For inside mount, measure inside of window frame; for outside mount, add the desired amount of overlap to your measurements
- See template instructions
- Side mount available up to 60" wide exact
- Liner available if fabric allows

**NOTE:** Arches can be made in Neat Pleat® fabrics, however they will not have the back loop tape.

Size Considerations				
Specialty	Minimum Width* (inches)	Maximum Width (inches)	Minimum Height (inches)	Maximum Height (inches)
Perfect Arch, Half Circle	9	96	4½	48
Palladian, Elongated, Eyebrow and Triangle	9	96	20% of width; minimum 4½	60% of width; max of 57.5
Quarter Circle	9	43	9	1.5 times width; max of 64.5

\*For all inside mount applications, ⅜" deduction is taken on overall width.

Recess Depth and Flush Mount	Minimum Recess Depth (inches)	Maximum Flush Mount (inches)
1" Pleated	1⅛	1⅛
2" Pleated	1⅛	2¼

## Options

### Specialty Shapes: Angle Top

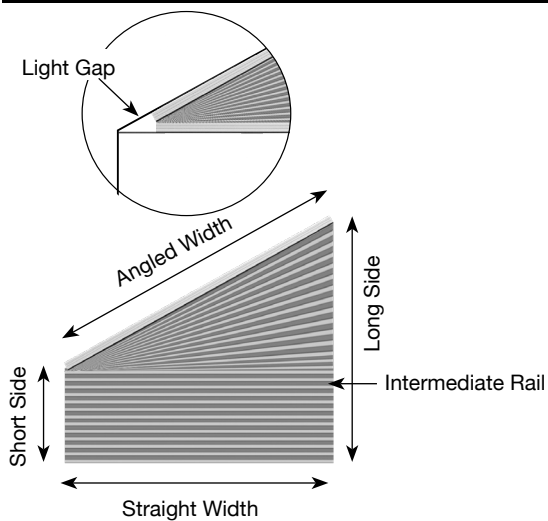

- Shade only lifts to intermediate rail, will not raise to complete angle
- As the low side measurement approaches 0", a light gap will exist to allow for the rails and fabrics to fit
- Not available with day liner or midnight liner only shades
- Only available as non-operable and 1" pleated fabric
- Side mount not available

Minimum Angled Width	12"
Maximum Angled Width	82"
Minimum Short Side Height	0"
Minimum Long Side Height	12"
Maximum Long Side Height	96"
Maximum Angled Top Degree	60° (degrees)

\*Maximum angled width determined by fabric width minus 2".

### SkyTrack™ Skylight

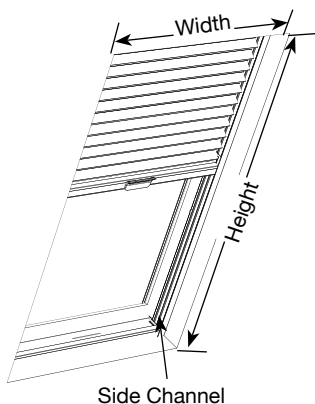

- **For surcharge, see price charts**
- Widths over 24¾" will have a center cord visible when the shade is open
- Includes color coordinated aluminum side channels. Colors available: Canyon Gray 053, Cream 715, Creamy Pearl 356, Revere Pewter 190, Sable 565, Smokey Gray 026, and White Satin 205
- Operates with handle on center rail
- Brackets will be visible on an outside mount
- Skylight poles are telescoping and available upon request
- Side mounts not available
- Skylights only available in 2" Neat Pleat® fabrics

Size Considerations	Minimum Recess (inches)	Flush Mount (inches)
Mounting Depth	1¼"	2½"



#### Sky Pole

Sizes available:  
3 to 6½ foot  
and 5 to 9½ foot

Size Considerations	Minimum Width (inches)	Maximum Width (inches)	Minimum Height (inches)	Maximum Height* (inches)
All Fabric Styles	12¾"	61"	12"	61"

\*For a width of 30¾" or less, maximum shade height is 96" .

# Options

## Enhanced Light Control Features

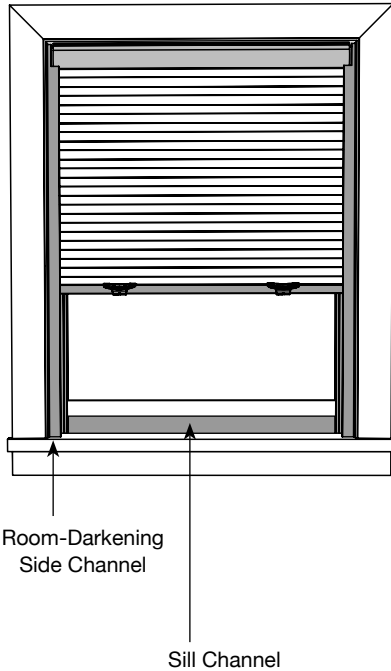

### Room-Darkening Side Channels

- **For surcharge, see price charts**
- Side channels boost room-darkening performance by reducing light leakage at sides of shades between the fabric and window frame
- Sill channel boosts room-darkening performance by reducing light leakage between the bottomrail and window frame
- Aluminum side channels come with a black PVC insert to absorb light and reflect it back outside for enhanced light blocking
- Maximizes privacy
- Ideal option for bedrooms, nurseries, and those who prefer blackout light control
- Available for 2" pleated shades with cordless lift, motorized lift
- Side channel colors available: Canyon Gray 053, Cream 715, Creamy Pearl 356, Revere Pewter 190, Sable 565, Smokey Gray 026, and White Satin 205
- Maximum width and height is 120" x 120"

# Options

## Making a Template for Specialty Windows

1. Tape butcher paper or heavy brown wrapping paper over the window opening allowing plenty of overlap.
2. Being careful not to press against the template paper while tracing, draw an exact outline of the window opening. Pressing on the template paper may distort the paper and cause the wrong size to be made.
3. Remove the paper from the window opening. If the shade is an outside mount, add the desired amount of overlap to the window outline. Draw a second outline around it to match the shape of the finished shade. **Be sure to erase the inside line.**
4. Mark the dimensions on the template. Check that the template dimensions match your measurements of the actual window opening.  
**NOTE: Make sure the template is of the window opening, not the measurement of the glass only.**
5. Cut the shape from the paper.
6. **PLACE THE TEMPLATE BACK INTO THE WINDOW OPENING TO CHECK FOR PROPER FIT.**
7. **Indicate on the template:**
  - “Room side” and “top”
  - **Purchase order number**
  - **Customer’s name**
  - **Your store name and account number**
8. Attach a copy of your purchase order to the template.
9. Roll up template and place in a mailing tube.  
**DO NOT FOLD TEMPLATE.**

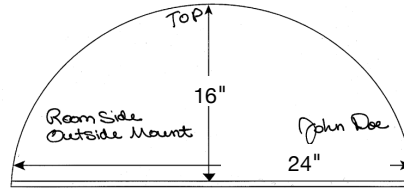

**Mail to:** Springs Window Fashions LLC  
8601 Route 405 Highway South, PO Box 500  
Montgomery, PA 17752  
ATTN: Specialty Department

**NOTE:** When mailing, make sure to get a tracking number and note your return address on the mailing tube.

### ACCEPTABLE MATERIALS FOR MAKING TEMPLATES

Kraft paper  
Butcher paper  
Construction paper

### WE WILL NOT ACCEPT TEMPLATES MADE FROM THE FOLLOWING MATERIALS

Newspaper	Plastic
Wax paper	Fabric
Tissue paper	Roofing paper
Existing arch shades	Wrapping paper
Cardboard	Poster board

**NOTE:** If the material used to make a template stretches, tears easily, will not lay flat, or will mark the fabric, IT WILL NOT BE USED.

## Using Template Service

### For surcharge, see price charts

To use the template service, simply:

1. Select template service when entering your order online.
2. Use the template worksheet to determine what measurements you need to supply for each shape.
3. Enter the lettered measurements using line item comments. The comments have been pre-programmed to all of the measurements you need to enter for your special shape.

For additional information, contact customer service.

# General Information

## Stack Height Chart

Height of Shade (inches)	1" Midnight Liner 1" Day liner (inches)	1" Pleated Fractured, Intuition, Luminance (inches)	1" Pleated Dundee, Dunes, Springleaf, Westport (inches)	1" Pleated Domain, Gabardine (inches)	2" Midnight Liner 2" Day liner (inches)	2" Pleated Dundee, Dunes, Intuition, Mountainside, Westport (inches)	2" Pleated Domain, Footpath, Gabardine, Gauze, Ornamental (inches)	2" Pleated Shoreline (inches)
18	2¼	2⅝	2½	2⅝	2⅝	2⅝	2⅝	3
30	2⅝	2⅝	3	3⅝	2¼	2½	2⅝	3⅝
42	2⅝	3	3⅝	3⅝	2¼	3	3⅝	3½
54	2½	3	3⅝	4⅞	2⅝	2⅝	3⅝	3⅝
66	2⅝	3¼	3⅝	4⅞	2⅝	3	3⅝	4⅞
78	2⅝	3⅝	3⅝	5⅞	2½	3⅝	4	4½
90	3	3⅝	4¼	6	2½	3⅝	4¼	4⅞
96	3	4	4⅝	6	2½	3⅝	4⅞	5⅞
108					2⅝	3⅝	4⅞	5½
120					2⅝	4	4⅞	6
132					2⅝	3⅝	5⅞	6⅞
144					3	4	5½	6½

### 1" and 2" Pleated Shades

For bottom up/top down with cordless lift controls add ¾" .

For sun up/sun down with cordless lift controls, add the two fabric stacks together.

**NOTE:** Stack height includes headrail and bottomrail. The stack measurements above are approximate. All stack heights as shown are without overlap, for overlap add an additional 60% to the given height for total stack height.

## General Information

### Stack Height Chart: Combination Shade

Height of Shade (inches)	Total Thickness			
	¾" Single Cell Hideaway, Sheer Bliss (inches)	¾" Single Cell Cosmopolitan BO, Heirloom LF & BO, Impresario BO, Restore BO, Serenade BO, Sunrise 9/16" Single Cell Sunrise (inches)	½" Double Cell Halo ¾" Single Cell Cosmopolitan LF, Halo, Impresario LF, Luminesce, Luxe LF & BO, Restore LF, Serenade LF, Spellbound 9/16" Single Cell Spellbound (inches)	½" Double Cell Hideaway (inches)
18	3½	3⅝	3⅝	4
30	3¾	4⅞	4⅞	4⅞
42	4⅞	4⅞	4¾	5
54	4½	5	5¼	5¼
66	5	5½	5¾	6
78	5¼	6	6¼	6¼
90	5⅝	6⅝	6¾	7⅞
96	5¾	6⅞	7	7⅞

**NOTE:** Sizes are approximate.

Stack height includes all rails and both pleated and cellular fabrics together, but is based on the cellular fabric chosen. Thickest pleated fabric was used for calculation.

# General Information

## Pleated Shade Color Coordination Chart

**NOTE:** Default color coordination is noted below. If desired, color coordination can be specified at the time of order.

Base Color	Default Rail Color	Rail Color Number
<b>Domain</b>		
Dried Mud	Revere Pewter	190
Frozen Gray	White Satin	205
Whale Gray	Canyon Gray	053
<b>Dundee</b>		
Carbon Ritz	Online	187
Diamond Aurora	White Satin	205
Filament	Cream	715
Silhouette	White Satin	205
<b>Dunes</b>		
Achroite	White Satin	205
Ash Tree	Canyon Gray	053
Bedrock	Canyon Gray	053
Toasted Vanilla	Creamy Pearl	356
Wood	Twine	439
<b>Footpath</b>		
Chocolate Milkshake	Revere Pewter	190
Dried Mud	White Satin	205
Frozen Gray	Revere Pewter	190
Pale Glacial Green	White Satin	205
Whale Gray	White Satin	205
<b>Fractured</b>		
Achroite	White Satin	205
Gray Wing	White Satin	205
Navy Pier	Navy	369
Stone Path	Revere Pewter	190
<b>Gabardine</b>		
Classic Khaki	Cream	715
Gray Suit	Canyon Gray	053
Subtle Graphite	Arctic Seal	183
Tan Trouser	Quietude	188
<b>Gauze</b>		
Blushing Gray	Smokey Gray	026
Bold Pecan	Watermelon Punch	196
Cream	White Satin	205
Loam	Revere Pewter	190
Shady	Cream	715

Base Color	Default Rail Color	Rail Color Number
<b>Intuition</b>		
Almond Milk	Creamy Pearl	356
Deep Soot	Black Satin	233
White Blossom	White Satin	205
<b>Luminance</b>		
Elegant Gray	Online	187
Fresh Lily	White Satin	205
Modern Cream	Cream	715
Pale Stone	Revere Pewter	190
Wedding White	White Satin	205
<b>Mountainside</b>		
Cloud Outline	White Satin	205
Natural Taupe	Twine	439
Shadowbrook	Smokey Gray	026
Sticky Rice	Cream	715
Storm Cloud	Online	187
<b>Ornamental</b>		
Achroite	White Satin	205
Arctic Bird	White Satin	205
Frosty	Cream	715
Whiskers	Canyon Gray	053
<b>Shoreline</b>		
Achroite	White Satin	205
Lamplight	Vanilla	100
Rodeo	Sable	565
Stone Path	Camel	086
<b>Springleaf</b>		
Apple Tree	White Satin	205
Blossom	White Satin	205
Flower Bouquet	White Satin	205
<b>Westport</b>		
Almost White	Cream	715
Bone	White Satin	205
Moonstone	Canyon Gray	053
Silky Taupe	Revere Pewter	190

# General Information

## Cordless Lift Product Detail

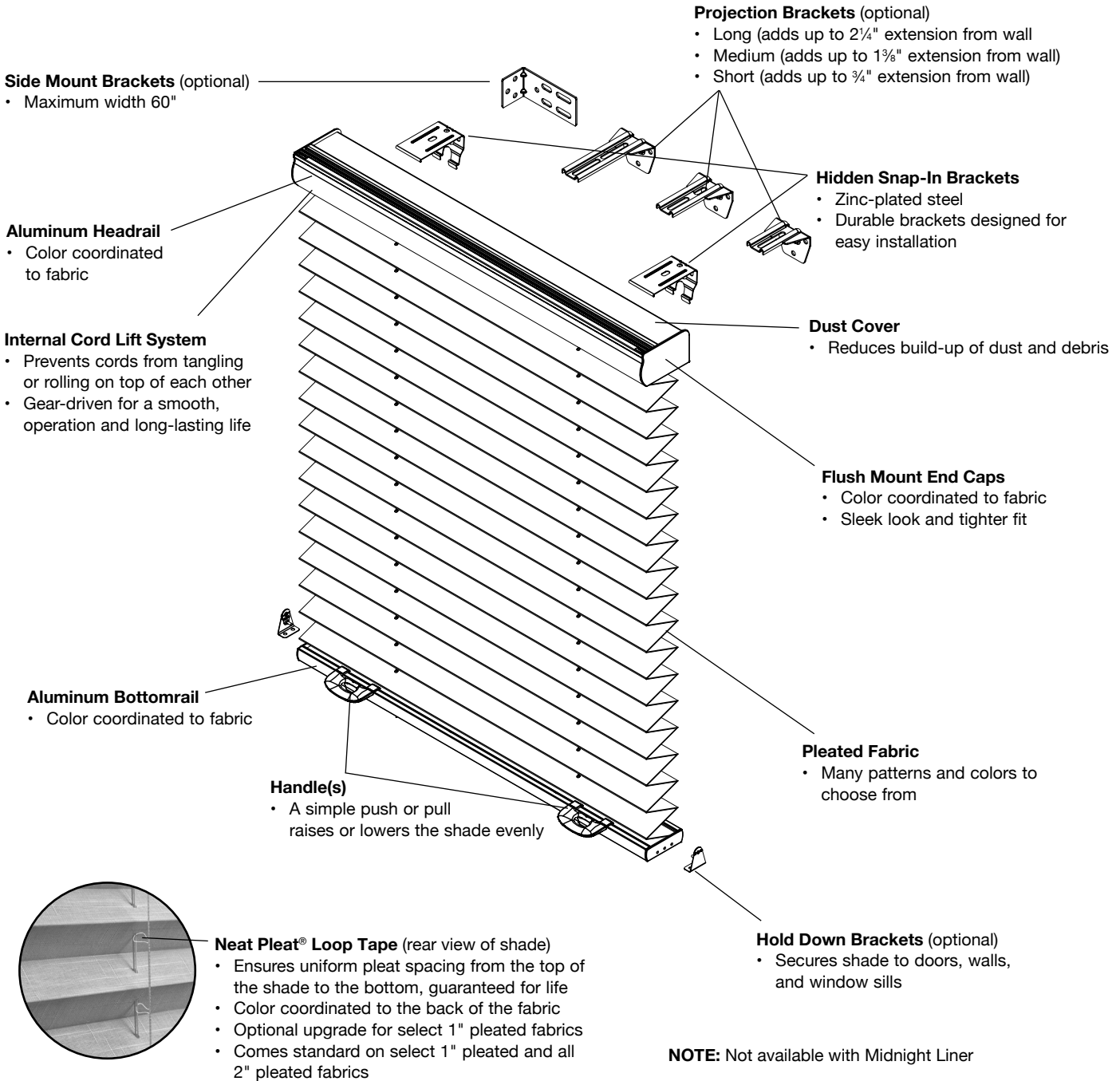

**NOTE:** Cordless lift shades should only be used on windows where consumers can comfortably raise and lower the shade with their hands and have easy access. Adding a sky pole is suggested for hard-to-reach applications, up to 24" wide. Sky poles are not recommended over 24"; however, if required, two sky poles should be ordered to ensure even operation. See options for details.



# General Information

## Continuous-Loop Lift Product Detail

**Side Mount Brackets** (optional)  
• Maximum width 60"

**Aluminum Headrail**  
• Color coordinated to shade fabric  
• Extremely durable

**Hold Down Brackets** (optional)  
• Secures shade to doors, walls, and window sills

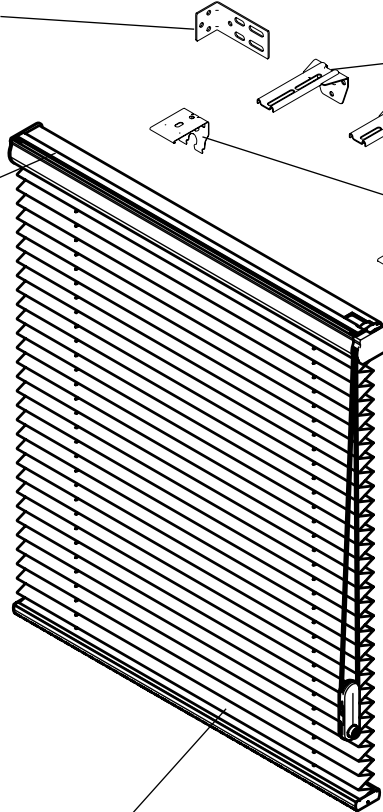

**Aluminum Bottomrail**  
• Color coordinated to fabric

**Projection Brackets** (optional)  
• Long (adds up to 2¼" extension from wall)  
• Medium (adds up to 1⅝" extension from wall)  
• Short (adds up to ¾" extension from wall)

**Hidden Snap-In Brackets**  
• Zinc-plated steel  
• Durable brackets designed for easy installation

**Continuous-Loop Lift Cord with Tension Device**  
• Length stays consistent regardless of shade height

**Safety Cord Loop Tensioner**  
• Must be mounted for safety and shade operation

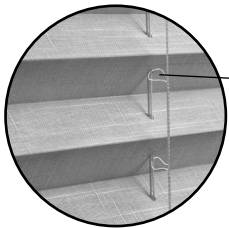

**Neat Pleat® Loop Tape** (rear view of shade)  
• Ensures uniform pleat spacing from the top of the shade to the bottom, guaranteed for life  
• Color coordinated to the back of the fabric  
• Optional upgrade for select 1" pleated fabrics  
• Comes standard on select 1" pleated and all 2" pleated fabrics

# General Information

## Bottom Up/Top Down: Cordless Lift Product Detail

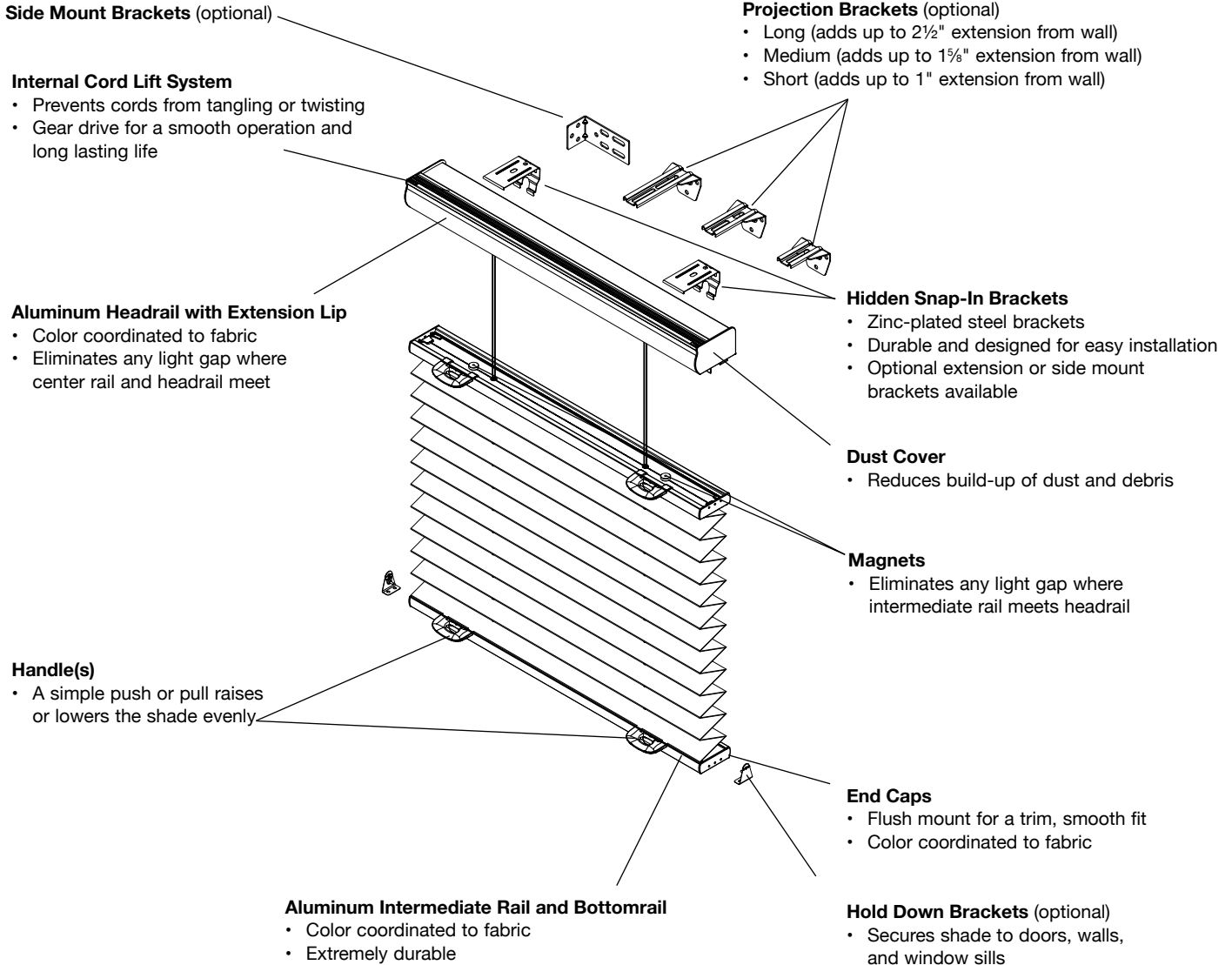

**NOTE:** Not available with Midnight Liner.

Cordless lift shades should only be used on windows where consumers can comfortably raise and lower the shade with their hands and have easy access.

# General Information

## Combination Shade Cordless Lift Product Detail

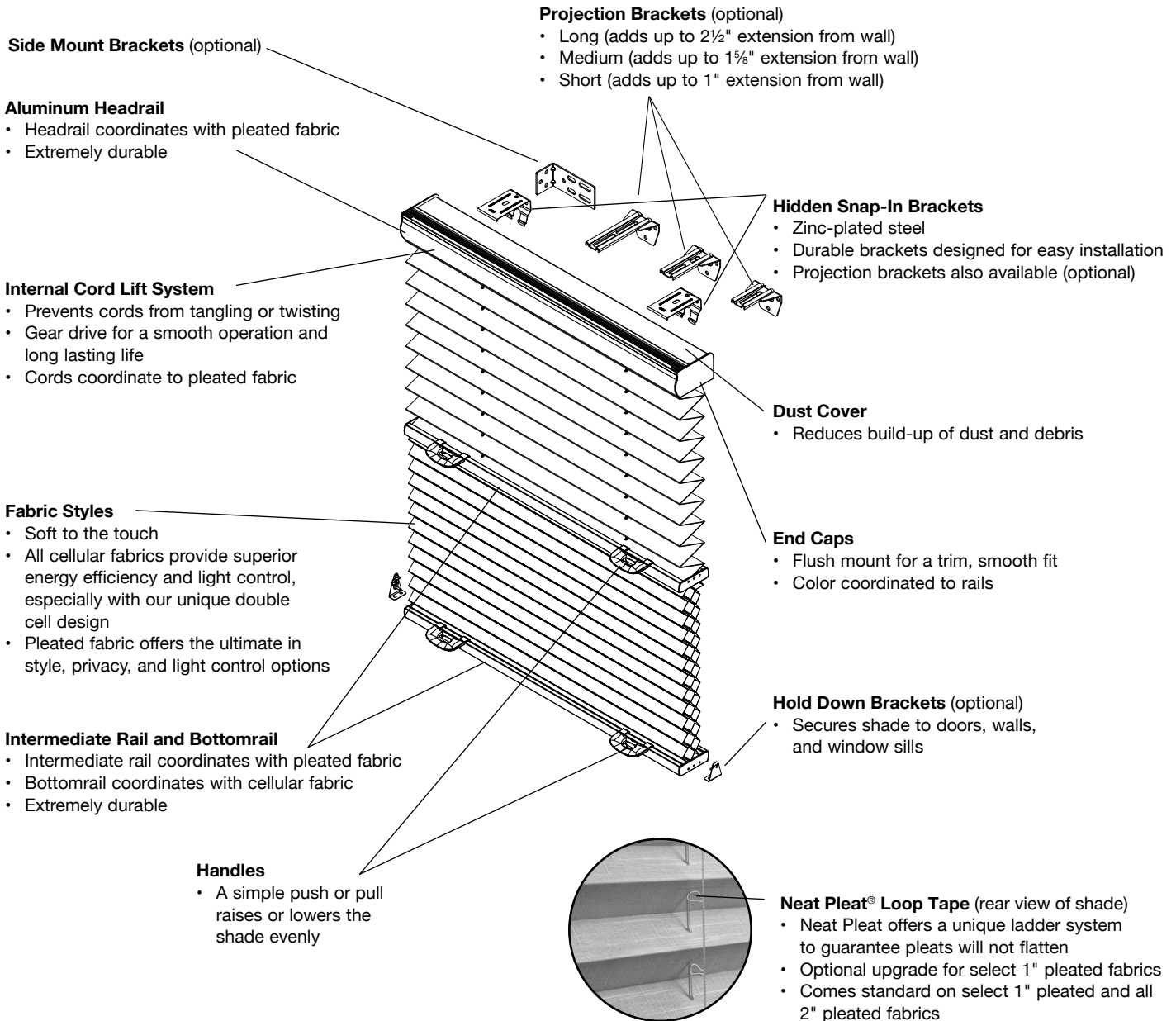

**NOTE:** Cordless lift shades should only be used on windows where consumers can comfortably raise and lower the shade with their hands and have easy access.



Bali is a brand of Springs Window Fashions, the Best Experience Company  
Bali and the Bali logo are registered trademarks of Springs Window Fashions, LLC.