

MOTORIZATION

Product Information Guide

Motorization Features and Size Considerations

Motorized Shades	2
Radio Frequency (RF)	2
Motorized Wand Lift	2
Cellular Shades Motorized Lift	3
Pleated Shades Motorized Lift	4
Classic Roman Shades Motorized Lift	5
Natural Shades Motorized Lift	6
Tailored Roman Shades Motorized Lift	7
Layered Shades Motorized Lift	8
Light Gap	8
Sheer Shades Motorized Lift	9
Light Gap	9
Roller and Solar Shades Motorized Lift	10
Motorized Lift and Dual Shade: Mounting Depth Illustrations	11
Minimum / Maximum Shade Size: Dual Shades	12-13
Minimum / Maximum Shade Size: 12-Volt Motorized Lift	14-16

Motorization Options

12-Volt Power Considerations	17-18
12-Volt Power Components	19
Motorization Control Options	20
Remote Mounting Options	21



APRIL 2026

Motorization Features

Motorized Shades

Refer to individual product information guide for specific shade options and pricing.

Radio Frequency (RF)

Bali motorized shades feature advanced Bluetooth and Z-Wave radio technology that provides reliable, effortless operation of window coverings. Our motorized shades are quiet, simple to install and adjust, and simple to operate. These automated shades also feature:

Refer to individual product information guide for specific option information for the product being ordered.

Bluetooth Radio Frequency Features

Bluetooth technology allows you to control your shades directly from your phone without a hub or gateway. Any iOS or Android device is compatible.



- Control your shades directly from your phone or tablet without a gateway
- Operate your shades within Bluetooth range
- Create and schedule routines to automate your window coverings
- A safer alternative to accessible cords; ideal for homes with children and pets
- Provides easy operation for hard to reach or large windows

Z-Wave Radio Frequency Features

- Conveniently operated from virtually anywhere in the home, up to 65 feet
- A safer alternative to accessible cords; ideal for homes with children and pets
- Provides easy operation for hard to reach or large windows
- Easily integrate with home automation and voice control devices

Control & Power Features and Options

- Control your shades directly from your smartphone or tablet
- Simple, intuitive control by means of the unique Standard Remote (not available with Cellular bottom up/ top down or Sheer & Layered)
- Plus Remote (single channel) or Premium Remote (multiple channel) also available to control shades individually or in a group
- LED feedback on controls to simplify operation and programming
- Low voltage motorization; no costly electrical hardwiring required
- See Motorization options section for additional control and power availability

Motorized Wand Lift

Motorized shades controlled by the motorized wand provide reliable, effortless operation of window coverings. Motorized shades with motorized wand lift are quiet, simple to install, and easy to operate.



Refer to individual product pages for specific option information for the product being ordered.

Features

- Simple, intuitive control by means of the motorized wand
- Consistent motor speed regardless of size or weight
- Efficiently manages energy (heat gain or loss)
- A safer alternative to cord lift options; ideal for homes with children and pets
- Clean design with LED operation confirmation
- LED feedback on the wand to simplify operation and programming
- Quiet, smooth shade operation
- “Limit Safety Protection” feature simplifies reprogramming, should it be necessary, while protecting the shade from damage
- Convenient soft-start and soft-end add a touch of class to shade travel
- Low-voltage motorization requires no costly electrical hard-wiring

Control Option Available

- Motorized wand—simple, convenient control at the window shade location
- Available in 24", 36", 48", and 84" lengths
- Available in White or Black

Motorized Wand

Control length for motorized wand lift shades varies based on finished shade height (above). Optional wand length can be specified at the time of order.

Finished Shade Height (inches)	Motorized Wand Length (inches)
up to 42	24
42 ¹ / ₁₆ to 54	36
54 ¹ / ₁₆ to 90	48
over 90	84

NOTE: Motorization components and accessories have a five-year limited warranty, excluding batteries.

Motorization Features and Size Considerations

Cellular Shades Motorized Lift

Order Entry: 12V Bluetooth and Z-Wave Motor or 12V Motorized Wand

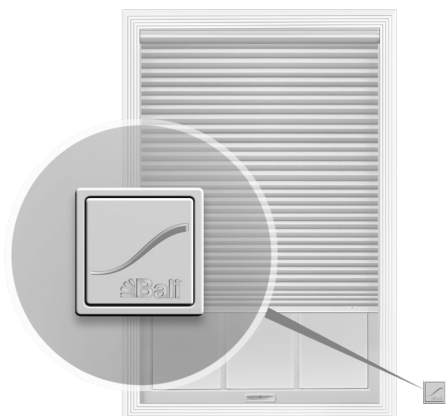

Refer to individual product information guide for specific option and size information for the product being ordered.

See page 2 for benefits of using Motorization.

Product Specifications

- Motor located on right side within headrail
- Available as corner and bay window application
- Available with Wood Cornice and Valance
- Available with reversible fabric
- Available with room-darkening side channels
- Available as bottom up/top down using the Bluetooth/Z-Wave motors. Not available with motorized wand
- Not available with top down continuous-loop, sun up/sun down, combination shades, SkyTrack™ Skylight, specialty shapes or multiple shades on one headrail
- Not available with hold down brackets or side mount brackets
- Bottom up/top down not available for Canada

Control and Power Options

- Multiple control and power options available; see Motorization options for availability

NOTE: Motorization components and accessories have a five-year limited warranty, excluding batteries.

See page 17 for Size Considerations by power source.

Size Considerations	Minimum Width (inches)	Maximum Width (inches)	Minimum Height (inches)	Maximum Height (inches)
Bluetooth and Z-Wave Motor	20	144*	9	144*
Bluetooth and Z-Wave Motor (Bottom Up/Top Down)	28 $\frac{5}{8}$	120	9	86
Motorized Wand	22	144*	18	144*

*This is the shade size maximum limit for this motor type, shades size limit may be smaller based on specific fabric type.

†For all inside mount applications, $\frac{5}{8}$ " deduction is taken by manufacturer on overall width.

Cell Size	Cellular Fabric Styles	Maximum Shade Size (square inches)	Bottom Up/Top Down Max Shade Size (square inches)
1/2" Double Cell	Hideaway	10,000	6,000
1/2" Double Cell	Halo	14,000	8,200
3/4" Single Cell	Cosmopolitan BO, Heirloom BO, Hideaway, Impresario BO, Restore BO, Luminesce, Luxe LF, Luxe BO, Serenade LF, Serenade BO	12,500	8,200
3/4" Single Cell	Cosmopolitan LF, Restore LF	14,000	9,200
3/4" Single Cell	Heirloom LF, Impresario LF	17,000	9,600
3/4" Single Cell	Halo, Sheer Bliss, Spellbound, Sunrise	20,800	10,600
5/8" Single Cell	Spellbound	12,500	N/A
5/8" Single Cell	Sunrise	17,000	N/A
1 1/4" Single Cell	Hideaway, Luminesce	12,500	8,200
1 1/4" Single Cell	Halo	14,000	9,200

BO=Blackout; LF=Light Filtering

†For all inside mount applications, $\frac{5}{8}$ " deduction is taken by manufacturer on overall width.

Depth Requirements for Inside Mount

Cell Size	Headrail Dimensions (inches)	Partially recessed headrail in window casing/molding. Minimum Depth Mount (inches)	Fully recessed headrail in window casing/molding. Flush with Casing (inches)
3/4" Single Cell 1/2" Double Cell	1 $\frac{1}{16}$ x 2 $\frac{3}{8}$	$\frac{5}{8}$	2 $\frac{3}{8}$
5/8" Single Cell	1 $\frac{1}{16}$ x 2 $\frac{1}{8}$	$\frac{5}{8}$	2 $\frac{3}{8}$
1 1/4" Single Cell	1 $\frac{5}{8}$ x 3 $\frac{3}{16}$	1 $\frac{3}{8}$	3 $\frac{3}{8}$

Motorization Features and Size Considerations

Pleated Shades Motorized Lift

Order Entry: 12V Bluetooth and Z-Wave Motor or 12V Motorized Wand

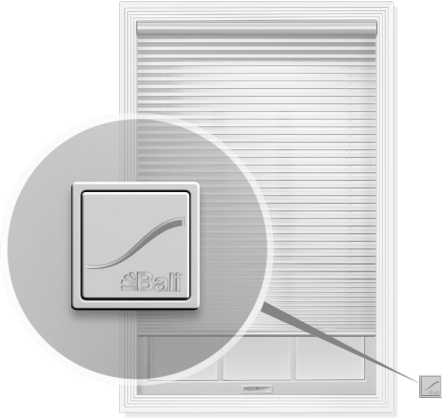

Refer to individual product information guide for specific option and size information for the product being ordered.

See page 2 for benefits of using Motorization.

Product Specifications

- Motor located on right side within headrail
- Available as corner and bay window application
- Available with Wood Cornice and Valance
- Available with Dayliner or Midnight liner
- Available with room-darkening channels
- Not available with bottom up/top down, sun up/sun down, combination shades, SkyTrack™ Skylight, specialty shapes or multiple shades on one headrail.
- Not available with hold down brackets or side mount brackets

Control and Power Options

- Multiple control and power options available; see Motorization options for availability

NOTE: Motorization components and accessories have a five-year limited warranty, excluding batteries.

See page 17 for Size Considerations by power source.

Pleated Fabric Styles	Maximum Shade Size (square inches)
2" Domain, Dundee, Dunes, Footpath, Gabardine, Gauze, Intuition, Mountainside, Ornamental, Shoreline	10,000
1" Domain, Dundee, Dunes, Gabardine, Intuition, Springleaf	12,500
1" Fractured, Luminance, Westport 2" Westport	14,000
1" Day and Midnight liner only shades 2" Day and Midnight liner only shades	17,000

Bluetooth and Z-Wave Motor	Minimum Width [†] (inches)	Maximum Width (inches)	Minimum Height (inches)	Maximum Height (inches)
1" Standard Pleat	20	144* [†]	9	96*
1" Neat Pleat®	20	120* [†]	6	96*
2" Neat Pleat	20	144* [†]	12	120*

Motorized Wand Lift	Minimum Width [†] (inches)	Maximum Width (inches)	Minimum Height (inches)	Maximum Height (inches)
1" Standard Pleat	22	144* [†]	18	96*
1" Neat Pleat®	22	120* [†]	18	96*
2" Neat Pleat	22	144* [†]	18	96*

*This is the shade size maximum limit for this motor type, shades size limit may be smaller based on specific fabric type.

[†]Based on fabric width with overlaps.

[‡]For all inside mount applications, 3/8" deduction is taken by manufacturer on overall width.

Depth Requirements for Inside Mount

Shade Type	Headrail Dimensions (inches)	Partially recessed headrail in window casing/molding Minimum Depth Mount (inches)	Fully recessed headrail in window casing/molding Flush with Casing (inches)
1" Pleat	1 1/16 x 2 1/8	3/8	2 3/8
2" Pleat	1 1/16 x 2 3/8	3/8	2 3/8

Motorization Features and Size Considerations

Classic Roman Shades Motorized Lift

Order Entry: 12V Bluetooth and Z-Wave Motor

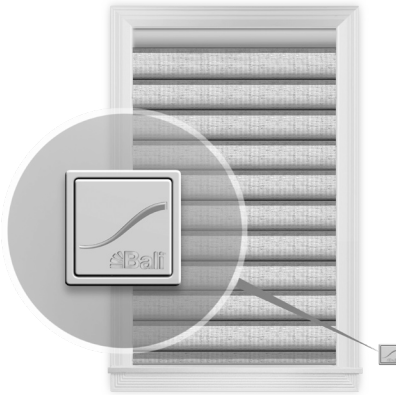

Refer to individual product information guide for specific option and size information for the product being ordered.

See page 2 for benefits of using Motorization.

Product Specifications

- Motor located on right side within headrail
- Available with both flat and looped styles
- Available as corner and bay window application
- Available with fabric valances and fabric valance trims
- Not available with multiple shades on one headrail
- Not available with hold down brackets or side mount brackets

Control and Power Options

- Multiple control and power options available; see Motorization options for availability

NOTE: Motorization components and accessories have a five-year limited warranty, excluding batteries.



See page 17 for Size Considerations by power source.

Classic Roman Size Considerations	Minimum Width* (inches)	Maximum Width (inches)	Minimum Height (inches)	Maximum Height (inches)
Flat or Looped	20	76 [†]	18	96

*For all inside mount applications, 3/8" deduction is taken by manufacturer on overall width.

[†]Based on fabric width.

Depth Requirements for Inside Mount

Headrail Dimensions (inches)	 Partially recessed headrail in window casing/molding Minimum Depth Mount (inches)	 Fully recessed headrail in window casing/molding Flush with Casing (inches)
1 1/16 x 2 1/2	5/8	2 1/2
1 1/16 x 2 1/8	5/8 (fabric loops will overhang approximately 3-in into the room)	2 1/2 (fabric loops will overhang approximately 3-in into the room)

Motorization Features and Size Considerations

Natural Shades Motorized Lift

Order Entry: 12V Bluetooth and Z-Wave Motor

Refer to individual product information guide for specific option and size information for the product being ordered.

See page 2 for benefits of using Motorization.

Product Specifications

- Motor located on underside of hardwood headrail on right side
- Available with Standard and Old Style Roman
- Available with multiple shades on one headrail; each panel will have a motor and power source and there will be ½" gap between panels
- Available with fabric edge banding, privacy and room-darkening liners
- Available with 9" standard valance, 9" palisade valance, or 9" deco-trim valance
- Available with accent gimp
- Available as corner and bay window application
- Available with Wood Cornice and Valance
- Not available with cut outs, turned headrail or specialty shapes
- Not available with hold down brackets or side mount brackets

Control and Power Options

- Multiple control and power options available; see Motorization options for availability

NOTE: Motorization components and accessories have a five-year limited warranty, excluding batteries.

See page 17 for Size Considerations by power source.

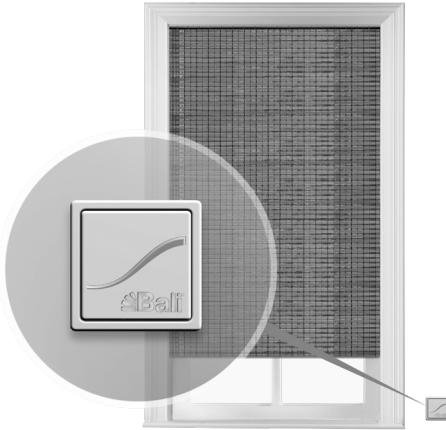

Natural Shades Size Considerations

Styles	Minimum Width (inches)	Maximum by Square Inches	
		Shade (square inches)	With Liner (square inches)
Antigua, Avonlea, Cabo, Maywood, Nicaragua, Zenon	18	2,755	2,333
Framework	18	4,493	3,466
Bead, Divan, Gemma, Seashell	18	5,194	3,878
Alondra, Faroe, Highpoint, Papua, Rattan, Ridge, Rila	18	6,058	4,330
Blended Grain, Ivan, Mill Cove	18	6,854	4,723
Desert Haze, Forage, Lagoon, Rugged Flax, Tarkine	18	9,149	5,712

Depth Requirements for Inside Mount

Headrail Dimensions (inches)	Minimum Depth Mount (inches)	Flush with Casing (inches)
¾ x 2¼	¾	Standard valance: 3¼

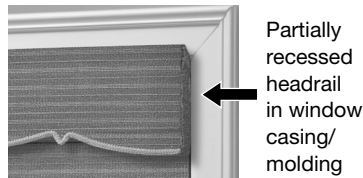

Minimum Depth Mount (inches)

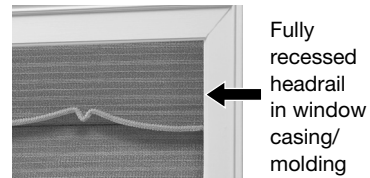

Flush with Casing (inches)

Motorization Features and Size Considerations

Tailored Roman Shades Motorized Lift

Order Entry: 12V Bluetooth and Z-Wave Motor

Refer to individual product information guide for specific option and size information for the product being ordered.

See page 2 for benefits of using Motorization.



Product Specifications

- Motor located on underside of hardwood headrail on right side
- Fabric wrapped headrail for a beautifully finished look; returns are standard on outside mount shades
- Available as pleat styles: Looped, classic flat, seamless, or relaxed
- Available with Liner styles: Standard and dimout
- Available finishing options: Inset banding, edge banding, decorative tape
- Not available with multiple shades on one headrail, bottom up/top down, turned headrail or blackout lining
- Not available with hold down brackets or side mount brackets

Control and Power Options

- Multiple control and power options available; see Motorization options for availability

NOTE: Motorization components and accessories have a five-year limited warranty, excluding batteries.

See page 17 for Size Considerations by power source.

Tailored Roman Shades Size Considerations

Width		Length		
Minimum (inches)	Maximum (inches)	Minimum (inches)	Maximum (inches)	
			Classic Flat, Seamless, Relaxed	Looped
24	96	18	120	103

Motorized Lift Maximum Shade Area in Square Inches

Fabric Name	12-volt Motorized Lift	
	Standard (square inches)	Dimout (square inches)
Gauze, Nadine	4,209	3,719
Ambrosia, Anita, Berrymeadow, Colton, Cubix, Cursive, Duke, Getaway, Gradual, Immersive, Intriguing, Lake Fog, Official, Playful, Poolside, Prep School, Resolute, Ruled, Seashore, Selena, Silverleaf, Sonoran, Squash, Timbre, Williams	3,569	3,245
Adalane, Alpaca, Aperture, City, Cusp, Graceful, Graze, Literature, Marino, Mason, Revive, Vibrant	2,921	2,859
Awash, Crescent Moss, Durham, EcoLuxe, Flourishing, Frosted, Gambrel, Hammond, Ionia, Optimal, Torrent, Wanderer	2,489	2,423

If fabric not listed, it is not available with the motorized lift option.

NOTE: Area is ordered width x ordered height in square inches.

Depth Requirements for Inside Mount

Headrail Dimensions (inches)	Minimum Depth Mount (inches)	Flush with Casing (inches)
2 1/4 D x 3/8 L	3/4	2 1/8

Partially recessed headrail in window casing/molding

Fully recessed headrail in window casing/molding

Motorization Features and Size Considerations

Layered Shades Motorized Lift

Order Entry: 12V Bluetooth and Z-Wave Motor



Refer to individual product information guide for specific option and size information for the product being ordered.

See page 2 for benefits of using Motorization.

Product Specifications

- Motor located on right or left side; standard is on right
- Available with Small Square or Round Fabric-wrapped Cassette
- Static-guard is necessary during dry conditions to prevent static build up
- Available as corner and bay window application
- Not available with hold down brackets or side mount brackets
- Not available with Wood Cornice or Valance

Control and Power Options

- Multiple control and power options available; see Motorization options for availability

NOTE: Motorization components and accessories have a five-year limited warranty, excluding batteries.

See page 17 for Size Considerations by power source.

Light Gap

The fabric width is narrower than the finished shade width of the tube and its components. See chart below for light gap.

Motor End		Idle End	
Inside Mount (inches)	Outside Mount (inches)	Inside Mount (inches)	Outside Mount (inches)
1 ¹ / ₁₆	1	3 ³ / ₄	1 ¹ / ₁₆

Layered Shades Size Considerations

Style Name	Maximum Width* (inches)	Maximum Height* (inches)
Aloft	98	110
Aloft Sparkle	98	110
Ashen	95	77
Bay Breeze	99	38
Beachcomber	95	108
Braided	98	91
Breezy	93	87
Coastal Beach	98	75
Grenada	96	110
Idyllic	93	95
Island Waves	96	81
Martingale	94	77
Relaxed Seas	99	110
Restful Linen	95	72
Salty Air	95	87
Sandy Isles	97	63
Seaport	99	110
Seashore	98	77
Sponson	97	84
Sunbaked Ember	100	110
Trimaran	97	77
Washed Sands	99	110

Minimum width: 16"
 Minimum length: 12"
 *If the height is shorter than the maximum, a slightly larger width may be available to order.
 Maximum width is 102".

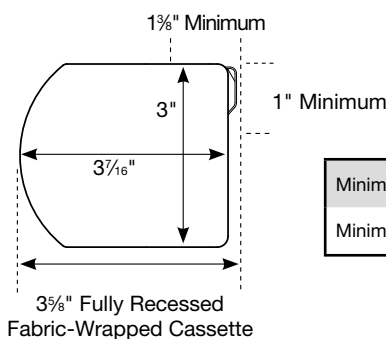

Minimum Mounting Depth	1 ¹ / ₈ "
Minimum Mounting Depth, Flush Mount	3 ⁵ / ₈ "

Motorization Features and Size Considerations

Sheer Shades Motorized Lift

Order Entry: 12V Bluetooth and Z-Wave Motor



Refer to individual product information guide for specific option and size information for the product being ordered.

See page 2 for benefits of using Motorization.

Product Specifications

- Motor located on right or left side; standard is on right
- Available with Small Square or Round Fabric-wrapped Cassette
- Available as corner and bay window application
- Not available with hold down brackets or side mount brackets
- Not available with Wood Cornice or Valance

Control and Power Options

- Multiple control and power options available; see Motorization options for availability

NOTE: Motorization components and accessories have a five-year limited warranty, excluding batteries.

See page 17 for Size Considerations by power source.

Light Gap

The fabric width is narrower than the finished shade width of the tube and its components. See chart below for light gap.

Motor End		Idle End	
Inside Mount (inches)	Outside Mount (inches)	Inside Mount (inches)	Outside Mount (inches)
1	1 ⁵ / ₁₆	1 ¹ / ₁₆	5 ⁵ / ₈

Sheer Shades Size Considerations

Style Name	Maximum Width* (inches)	Maximum Height* (inches)
Contemporary 2"	96	105
Diamond Radiance 2"	96	105
Diamond Radiance 3"	96	65
Glimmer 2"	96	105
Grafton 2"	96	105
Grafton 3"	96	105
Grafton Glitter 2"	98	110
Grafton Glitter 3"	98	110
Grafton Weave 2"	96	110
Grafton Weave 3"	96	110
Grand Illusion 2"	96	105
Hurricane 2"	96	105
Lattice 2"	96	105
Raina 3"	96	65
Rooted Earth 2"	89	110
Soft Glow 2"	85	100
Tisbury 1"	94	75
Westford 2"	94	99
Westford 2 ³ / ₄ "	94	98
Woven Grids 2"	96	110
Woven Grids 3"	96	65

Minimum width: 16"
 Minimum length: 12"
 *If the height is shorter than the maximum, a slightly larger width may be available to order.
 Maximum width is 102".

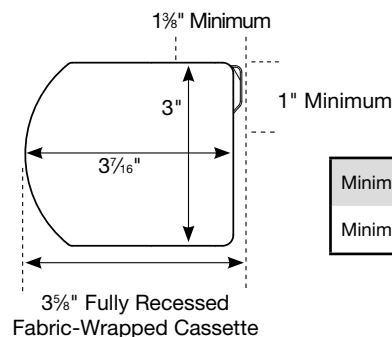

Minimum Mounting Depth	1 ¹ / ₈ "
Minimum Mounting Depth, Flush Mount	3 ⁵ / ₈ "

Motorization Features and Size Considerations

Roller and Solar Shades Motorized Lift

Order Entry: 12V Bluetooth and Z-Wave Motor or 12V Motorized Wand

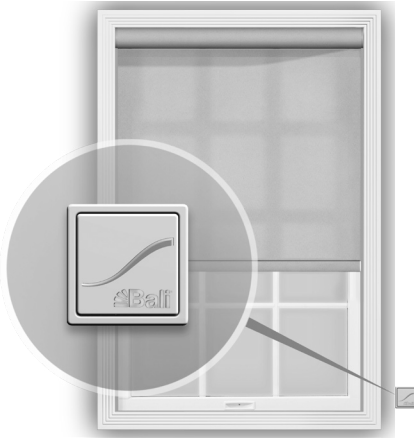

Refer to individual product information guide for specific option and size information for the product being ordered.

See page 2 for benefits of using Motorization.

Product Specifications

- Motor located on right or left side; standard is on right
- Available with standard or reverse roll; reverse roll not available with any valance option
- Available with valance styles: cassette, contour, flat, wood valance and wood cornice
- Available as corner and bay window application
- Available with fabric rotated 90° (width for height)
- Available with as Dual Shade (integrates two fabrics that can be independently raised and lowered as needed; each shade requires a power source)
- Not available with hold down brackets

Control and Power Options

- Multiple control and power options available; see Motorization options for availability

NOTE: Motorization components and accessories have a five-year limited warranty, excluding batteries.

See page 17 for Size Considerations by power source.

Inside Mount Light Gap

Light Gap		
Valance Type	Motor End (Inside Mount)	Idle End (Inside Mount)
Contour, Flat, No Valance	$\frac{9}{16}$	$\frac{7}{8}$
Cassette - all sizes	$\frac{9}{16}$	1
Dual - No Cassette N/A with Motorized Wand	$\frac{9}{16}$	$\frac{7}{8}$

Size Considerations

Minimum Width (inches)	Minimum Height (inches)
16	13

Motorization Size Considerations

Motorized Lift and Dual Shade: Mounting Depth Illustrations

The following diagrams illustrate the mounting depth requirements for shades mounted inside window casements.

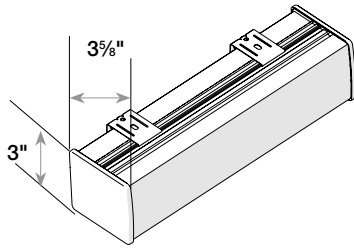

Small Square Cassette Valance
1 3/8" Minimum Inside Mount

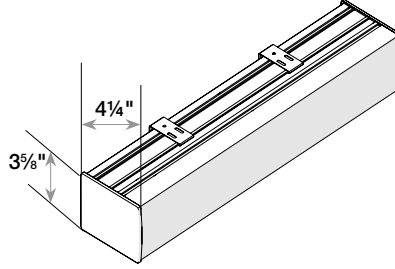

Medium Square Cassette Valance
1 3/4" Minimum Inside Mount

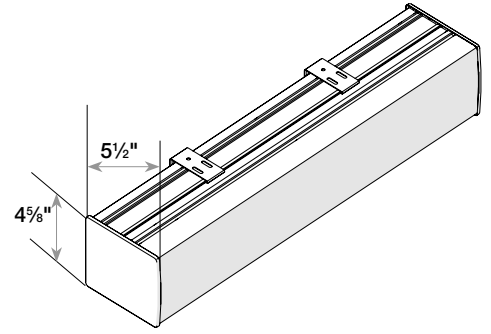

Large Square Cassette Valance
1 3/4" Minimum Inside Mount

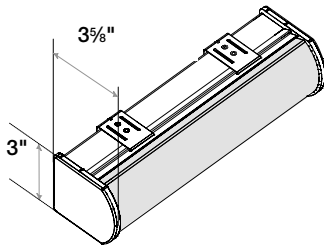

Small Round Cassette Valance
1 3/8" Minimum Inside Mount

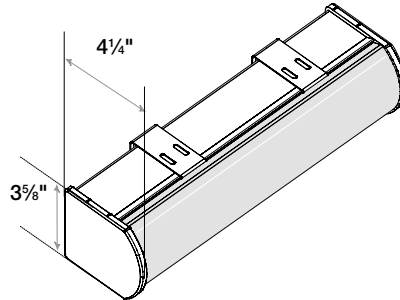

Medium Round Cassette Valance
1 3/4" Minimum Inside Mount

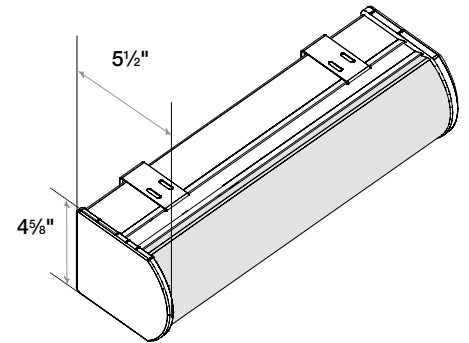

Large Dual Round Cassette Valance
1 3/4" Minimum Inside Mount

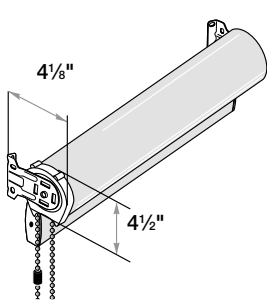

No Valance*
3/4" Minimum Inside/Side Mount

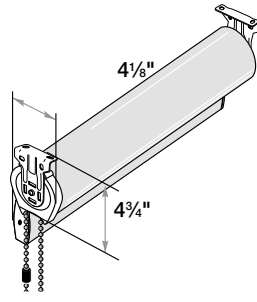

No Valance*
4 1/8" Minimum Inside/Top Mount

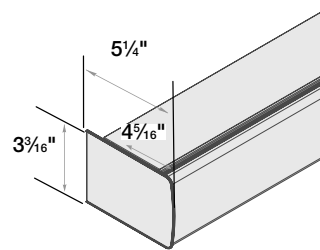

Contour Valance
2 7/16" Minimum Inside Mount
(return can be trimmed)

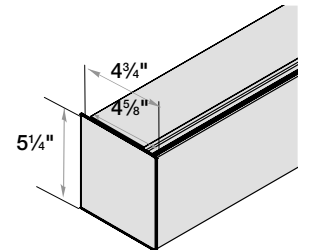

Flat Valance
2 15/16" Minimum Inside Mount
(return can be trimmed)

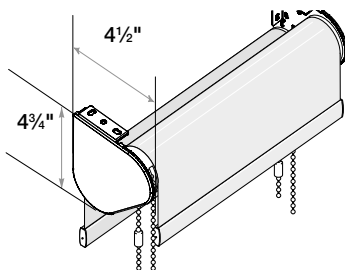

Dual Shade—No Cassette Valance
2" Minimum Inside/Top Mount
3/4" Minimum Inside/Side Mount
Not available with Motorized Wand

Motorization Features and Size Considerations

This table provides the maximum shade size available by fabric. Not available with Motorized Wand Lift for dual shades.

Fabric turned width for height (railroaded) may curl along its edge. This is not a defect in the product.

Scallops will decrease the maximum height by 6¼" for roller fabrics only.

Minimum Shade Size

For all fabrics: minimum shade width: 16"; minimum shade height: 13"

Maximum Shade Size: Dual Shades

Fabric Styles	Normal Orientation		Fabric Turned Width for Height (railroaded)			
	12 Volt Motor No Cassette/No Valance		12 Volt Motor No Cassette/ No Valance at Max Length		12 Volt Motor No Cassette/ No Valance at Max Width	
	Width (inches)	Height (inches)	Width (inches)	Height (inches)	Width (inches)	Height (inches)
Acadia BO	63	81	NO RR	NO RR	NO RR	NO RR
Acadia LF	72	89	NO RR	NO RR	NO RR	NO RR
Andes	91	131	NO RR	NO RR	NO RR	NO RR
Basics	70	144	77	62	91	60
Baybridge (Hubcap)	77	62	NO RR	NO RR	NO RR	NO RR
Boyden	81	82	NO RR	NO RR	NO RR	NO RR
Candid (Flecked White)	88	115	NO RR	NO RR	NO RR	NO RR
Candid (Toasted Sugar)	82	111	NO RR	NO RR	NO RR	NO RR
Candid (Brown Influence, Smokey Taupe, Snow Fall, Speckled Black)	85	115	NO RR	NO RR	NO RR	NO RR
Cascade	91	122	NO RR	NO RR	NO RR	NO RR
Domain	89	110	NO RR	NO RR	NO RR	NO RR
Dundee	92	123	83	84	98	82
EcoLiving	95	119	NO RR	NO RR	NO RR	NO RR
EnviroStyle	94	122	NO RR	NO RR	NO RR	NO RR
Estevan (Subdued White, Faded Wood, Fossil Stone, Strong Chocolate)	89	133	NO RR	NO RR	NO RR	NO RR
Estevan (Garden)	89	114	NO RR	NO RR	NO RR	NO RR
Everly	95	114	NO RR	NO RR	NO RR	NO RR
Explorer	94	119	NO RR	NO RR	NO RR	NO RR
Feedback 1%	79	92	79	92	79	92
Feedback 10%	82	102	82	102	82	102
Feedback 3%	79	97	79	97	79	97
Feedback 5%	81	101	81	101	81	101
Fiji BO	82	98	NO RR	NO RR	NO RR	NO RR
Fiji LF	94	110	NO RR	NO RR	NO RR	NO RR
Flagstone	79	106	82	105	82	105
Gabardine	89	125	NO RR	NO RR	NO RR	NO RR
Garden Path	81	68	NO RR	NO RR	NO RR	NO RR
Harbor	70	131	NO RR	NO RR	NO RR	NO RR
Hopewell	92	120	NO RR	NO RR	NO RR	NO RR
Kyoto	79	112	NO RR	NO RR	NO RR	NO RR
Landon (Warm Carmel)	71	83	NO RR	NO RR	NO RR	NO RR
Linen	72	81	NO RR	NO RR	NO RR	NO RR
Mountainside BO	65	126	NO RR	NO RR	NO RR	NO RR
Mountainside LF	82	141	74	84	87	82

Due to continuous manufacturing improvements, minimums and maximums are subject to change. Please call customer service for up to date size considerations.

Motorization Features and Size Considerations

This table provides the maximum shade size available by fabric for dual shades.

Scallops will decrease the maximum height by 6¾" for roller fabrics only.

Fabric turned width for height (railroaded) may curl along its edge. This is not a defect in the product.

Minimum Shade Size

For all fabrics: minimum shade width: 16"; minimum shade height: 13"

Maximum Shade Size: Dual Shades

Fabric Styles	Normal Orientation		Fabric Turned Width for Height (railroaded)			
	12 Volt Motor No Cassette/No Valance		12 Volt Motor No Cassette/ No Valance at Max Length		12 Volt Motor No Cassette/ No Valance at Max Width	
	Width (inches)	Height (inches)	Width (inches)	Height (inches)	Width (inches)	Height (inches)
Muse 1%	72	73	72	73	84	58
Muse 5%	73	79	73	79	85	63
Mystify	79	84	NO RR	NO RR	NO RR	NO RR
Navigator BO (Midnight Plum, Cool Honeydew)	75	123	95	66	95	66
Navigator BO (Candelabra, Ivory Cream, Barnhouse Beige, Denim Jacket, Discord, Black Ink)	86	123	89	105	89	105
Navigator LF (Midnight Plum, Cool Honeydew)	75	144	100	66	100	66
Navigator LF (Candelabra, Ivory Cream, Barnhouse Beige, Denim Jacket, Discord, Black Ink)	93	122	95	105	95	105
Ornamental	91	102	NO RR	NO RR	NO RR	NO RR
Ornamental BO (Achroite, Beech Gray, Chalkboard, Fossil Stone, James Bay Gray)	82	94	NO RR	NO RR	NO RR	NO RR
Ornamental BO (Cool Honeydew, Midnight Plum)	75	123	95	66	95	66
Ornamental LF (Cool Honeydew, Midnight Plum)	75	144	100	66	100	66
Ornamental LF (Barnhouse Beige, Black Ink, Candelabra, Denim Jacket, Discord, Ivory Cream)	93	122	95	105	95	105
Rustic (Classic Beige, Birchwood)	70	109	NO RR	NO RR	NO RR	NO RR
Rustic (Fresh White, Spring Denim, Sand Dune, Antique Silver)	70	90	NO RR	NO RR	NO RR	NO RR
SafeElements	79	89	83	87	86	73
Santina	71	56	NO RR	NO RR	NO RR	NO RR
Sovereign	82	102	87	102	88	102
Viewpoint	87	107	89	106	89	106
Viva	94	121	NO RR	NO RR	NO RR	NO RR

Due to continuous manufacturing improvements, minimums and maximums are subject to change. Please call customer service for up to date size considerations.

Motorization Features and Size Considerations

This table provides the maximum shade size available by fabric for motorized lift shades. Fabric turned width for height (railroaded) may curl along its edge. This is not a defect in the product. Scallops will decrease the maximum height by 6¾" for roller fabrics only. Available valance options are cassette and contour. No valance option is also available.

Minimum Shade Size

Maximum Shade Size: 12-Volt Motorized Lift

Fabric Styles	Normal Fabric Orientation						Fabric Turned Width for Height (railroaded)					
	Small Cassette		Medium Cassette		Large Cassette/ Contour Valance/ Flat Valance/ No Cassette/ No Valance		Small Cassette		Medium Cassette		Large Cassette/ Contour Valance/ Flat Valance/ No Cassette/ No Valance at Max Length	
	Width (inches)	Height (inches)	Width (inches)	Height (inches)	Width (inches)	Height (inches)	Width (inches)	Height (inches)	Width (inches)	Height (inches)	Width (inches)	Height (inches)
Acadia BO	56	84	63	109	63	109	NO RR	NO RR	NO RR	NO RR	NO RR	NO RR
Acadia LF	73	93	72	110	72	110	NO RR	NO RR	NO RR	NO RR	NO RR	NO RR
Andes	91	131	91	131	91	131	NO RR	NO RR	NO RR	NO RR	NO RR	NO RR
Basics	70	144	70	144	70	144	77	62	77	62	77	62
Baybridge (Hubcap)	77	64	84	98	80	122	NO RR	NO RR	NO RR	NO RR	NO RR	NO RR
Boyzden	74	84	81	124	81	124	NO RR	NO RR	NO RR	NO RR	NO RR	NO RR
Candid (Fleeced White)	88	120	88	124	88	124	NO RR	NO RR	NO RR	NO RR	NO RR	NO RR
Candid (Toasted Sugar)	88	98	82	144	82	144	NO RR	NO RR	NO RR	NO RR	NO RR	NO RR
Candid (Brown Influence, Smokey Taupe, Snow Fall, Speckled Black)	74	115	85	133	85	133	NO RR	NO RR	NO RR	NO RR	NO RR	NO RR
Cascade	78	126	91	136	91	136	NO RR	NO RR	NO RR	NO RR	NO RR	NO RR
Domain	78	112	89	135	89	135	NO RR	NO RR	NO RR	NO RR	NO RR	NO RR
Dundee	92	127	92	137	92	137	83	84	83	84	83	84
EcoLiving	95	119	95	119	95	119	NO RR	NO RR	NO RR	NO RR	NO RR	NO RR
EnviroStyle	94	122	94	122	94	122	NO RR	NO RR	NO RR	NO RR	NO RR	NO RR
Estevan (Subdued White, Faded Wood, Fossil Stone, Strong Chocolate)	89	133	89	133	89	133	NO RR	NO RR	NO RR	NO RR	NO RR	NO RR
Estevan (Garden)	90	118	89	132	89	132	NO RR	NO RR	NO RR	NO RR	NO RR	NO RR
Every	95	118	95	125	95	125	NO RR	NO RR	NO RR	NO RR	NO RR	NO RR
Explorer	94	119	94	119	94	119	NO RR	NO RR	NO RR	NO RR	NO RR	NO RR
Feedback 1%	82	96	79	116	79	116	82	96	79	114	79	114
Feedback 10%	84	106	82	123	82	123	84	106	84	106	84	106
Feedback 3%	82	101	79	122	79	122	82	101	80	114	80	114
Feedback 5%	83	106	81	121	81	121	83	106	82	114	82	114

Due to continuous manufacturing improvements, minimums and maximums are subject to change. Please call customer service for up to date size considerations.

Motorization Features and Size Considerations

This table provides the maximum shade size available by fabric for motorized lift shades. Fabric turned width for height (railroaded) may curl along its edge. This is not a defect in the product. Scallops will decrease the maximum height by 6¼" for roller fabrics only. Available valance options are cassette and contour. No valance option is also available.

Minimum Shade Size

For all fabrics: minimum shade width: 16", minimum shade height: 13"

Maximum Shade Size: 12-Volt Motorized Lift

Fabric Styles	Normal Fabric Orientation						Fabric Turned Width for Height (railroaded)					
	Small Cassette		Medium Cassette		Large Cassette/ Contour Valance/ Flat Valance/ No Cassette/ No Valance		Small Cassette		Medium Cassette		Large Cassette/ Contour Valance/ Flat Valance/ No Cassette/ No Valance at Max Length	
	Width (inches)	Height (inches)	Width (inches)	Height (inches)	Width (inches)	Height (inches)	Width (inches)	Height (inches)	Width (inches)	Height (inches)	Width (inches)	Height (inches)
Fiji BO	72	101	82	123	82	123	NO RR	NO RR	NO RR	NO RR	NO RR	NO RR
Fiji LF	94	118	94	119	94	119	NO RR	NO RR	NO RR	NO RR	NO RR	NO RR
Flagstone	81	112	79	126	79	126	82	105	82	105	82	105
Gabardine	92	106	89	132	89	132	NO RR	NO RR	NO RR	NO RR	NO RR	NO RR
Garden Path	76	70	83	108	81	124	NO RR	NO RR	NO RR	NO RR	NO RR	NO RR
Harbor	70	135	70	144	70	144	NO RR	NO RR	NO RR	NO RR	NO RR	NO RR
Hopewell	92	124	92	144	92	144	NO RR	NO RR	NO RR	NO RR	NO RR	NO RR
Kyoto	79	96	79	144	79	144	NO RR	NO RR	NO RR	NO RR	NO RR	NO RR
Landon (Warm Carmel)	71	85	79	111	79	111	NO RR	NO RR	NO RR	NO RR	NO RR	NO RR
Linen	72	84	72	144	72	144	NO RR	NO RR	NO RR	NO RR	NO RR	NO RR
Mountainside BO	65	126	65	126	65	126	NO RR	NO RR	NO RR	NO RR	NO RR	NO RR
Mountainside LF	82	141	82	141	82	141	74	84	74	84	74	84
Muse 1%	67	75	72	89	72	89	67	75	72	89	72	89
Muse 5%	68	81	73	96	73	96	68	81	73	96	73	96
Mystify	71	84	79	110	79	110	NO RR	NO RR	NO RR	NO RR	NO RR	NO RR
Navigator BO (Midnight Plum, Cool Honeydew)	75	128	75	144	75	144	95	66	95	66	95	66
Navigator BO (Candela, Ivory Cream, Barnhouse Beige, Denim Jacket, Discord, Black Ink)	86	127	85	135	85	135	89	105	89	105	89	105
Navigator LF (Midnight Plum, Cool Honeydew)	75	144	75	144	75	144	100	66	100	66	100	66
Navigator LF (Candela, Ivory Cream, Barnhouse Beige, Denim Jacket, Discord, Black Ink)	93	122	93	122	93	122	95	105	95	105	95	105

Motorization Features and Size Considerations

This table provides the maximum shade size available by fabric for motorized lift shades. Fabric turned width for height (railroaded) may curl along its edge. This is not a defect in the product. Scallops will decrease the maximum height by 6¾" for roller fabrics only. Available valance options are cassette and contour. No valance option is also available.

Minimum Shade Size

For all fabrics: minimum shade width: 16", minimum shade height: 13"

Maximum Shade Size: 12-Volt Motorized Lift

Fabric Styles	Normal Fabric Orientation						Fabric Turned Width for Height (railroaded)					
	Small Cassette		Medium Cassette		Large Cassette/ Contour Valance/ Flat Valance/ No Cassette/ No Valance		Small Cassette		Medium Cassette		Large Cassette/ Contour Valance/ Flat Valance/ No Cassette/ No Valance at Max Length	
	Width (inches)	Height (inches)	Width (inches)	Height (inches)	Width (inches)	Height (inches)	Width (inches)	Height (inches)	Width (inches)	Height (inches)	Width (inches)	Height (inches)
Ornamental	79	105	91	128	91	128	NO RR	NO RR	NO RR	NO RR	NO RR	NO RR
Ornamental BO (Achrome, Beech Gray, Chalkboard, Fossil Stone, James Bay Gray)	74	96	82	134	82	134	NO RR	NO RR	NO RR	NO RR	NO RR	NO RR
Ornamental BO (Cool Honeydew, Midnight Plum)	75	128	75	144	75	144	95	66	95	66	95	66
Ornamental LF (Cool Honeydew, Midnight Plum)	75	144	75	144	75	144	100	66	100	66	100	66
Ornamental LF (Barnhouse Beige, Black Ink, Candalaria, Denim Jacket, Discord, Ivory Cream)	93	122	93	122	93	122	95	105	95	105	95	105
Rustic (Classic Beige, Birchwood)	70	112	70	144	70	144	NO RR	NO RR	NO RR	NO RR	NO RR	NO RR
Rustic (Fresh White, Spring Denim, Sand Dune, Antique Silver)	70	93	70	142	70	144	NO RR	NO RR	NO RR	NO RR	NO RR	NO RR
SafeElements	70	89	79	109	79	109	70	87	83	86	83	86
Santina	67	58	73	89	71	103	NO RR	NO RR	NO RR	NO RR	NO RR	NO RR
Sovereign	87	106	82	144	82	144	87	106	87	108	87	108
Viewpoint	89	111	87	127	87	127	89	106	89	106	89	106
Viva	94	121	94	121	94	121	NO RR	NO RR	NO RR	NO RR	NO RR	NO RR

Due to continuous manufacturing improvements, minimums and maximums are subject to change. Please call customer service for up to date size considerations.

Motorization Power Options

12-Volt Power Considerations

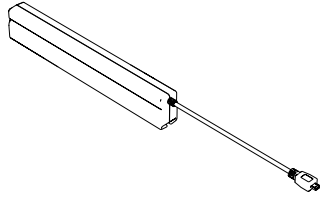

Rechargeable Battery Pack

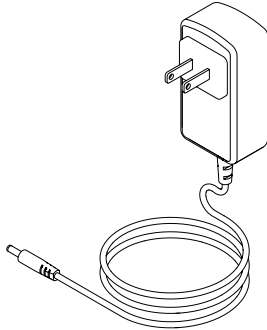

Li-Ion Charger

Motors can be powered by a rechargeable battery pack or plug-in transformer. Each shade requires a motor and appropriate power source.

Power Considerations

Larger shades consume more power while operating. Choose the appropriate power source based upon the shade size.

Shade Size square inches (cm ²)	Non-Rechargeable Recommended Power Source	Rechargeable Battery Pack Estimated Battery Life Before Recharge* Single Pack Only
0 to 3,600 (0 to 23,225.8)	Plug-in	≈12 months
3,600 to 7,200 (23,225.8 to 46,451.5)	Plug-in	≈6-12 months
>7,200 (46,451.5)	Plug-in	≈6 months or Less

NOTE: For best performance with non-rechargeable solutions, use only AA lithium batteries.

Motorized Wand Power Source	Estimated Life (Average Size Shade: 48" x 60")
Rechargeable Li-Ion Battery Pack	3+ Years (before recharge)

Based on average size shade, opening and closing once per day.

Power Source	Dimensions
Rechargeable battery pack	8 ⁹ / ₁₆ " x 1 ⁷ / ₁₆ " x 1 ⁵ / ₁₆ "

Rechargeable Battery Pack

- Multiple mounting options provided
- The rechargeable battery pack comes as a sealed pack with the batteries already included. Batteries are charged by plugging the charger into the pack
- Can add maximum two motor-to-power extensions per motor, available in 48" (122.0 cm and 96" (243.9 cm)
- Rechargeable battery packs ship at 30% charge and must be fully charged prior to installation
- Dual pack configuration is not available or necessary for the rechargeable battery packs
- One Lithium-Ion Charger is required per order; sold separately
- Lithium-Ion charger cable is 6 ft. (1.9 m)
- Lithium-Ion charger has an LED that turns red to indicate charging and green to indicate fully charged
- Fully charging the rechargeable battery pack takes an average of 5 hours

Motorization Power Options

12-Volt Power Considerations

Battery Pack Considerations

Battery packs are installed in space outside of the product and can be a challenge to hide in some windows.

Solar/Roller, Natural Shades, Tailored Roman Shade Battery Considerations

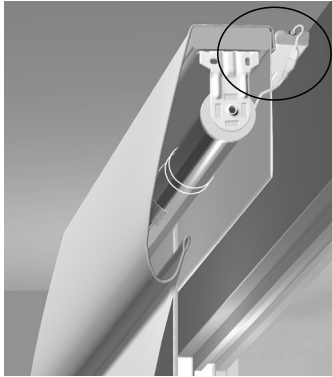

Tailored Roman/Natural Shades
Battery Pack
Mounted Behind

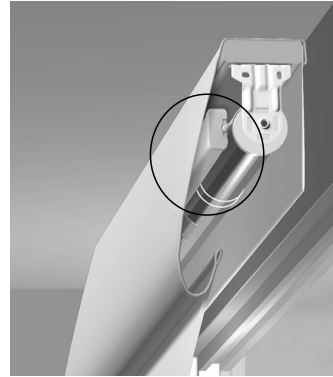
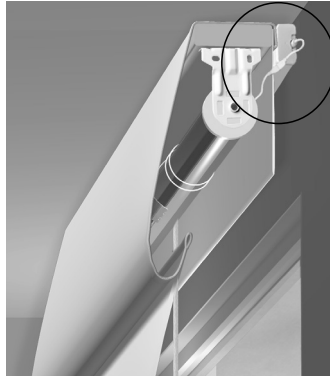

Tailored Roman/Natural Shades
Battery Pack
Mounted on Headrail

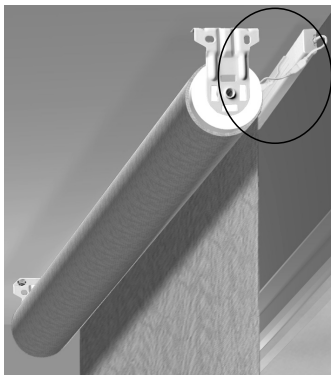

Solar and Roller Shades
Outside Mount
Battery Pack

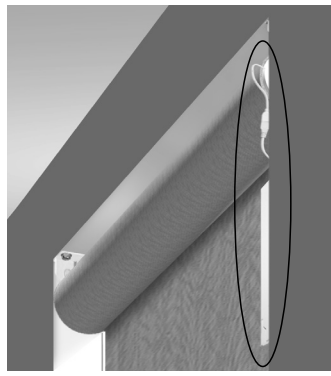

Solar and Roller Shades
Inside Mount Battery Pack

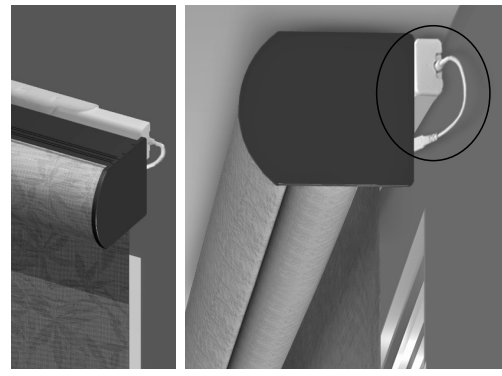

Solar, Roller, Layered, and
Sheer Shades with Cassette
Battery Pack

Cellular, Pleated and Classic Roman Shade Battery Considerations

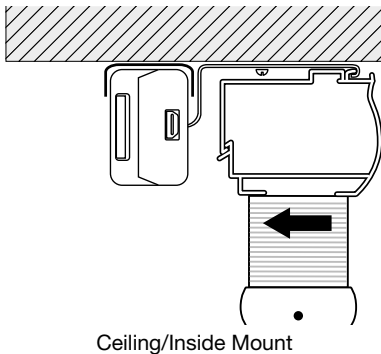

Ceiling/Inside Mount

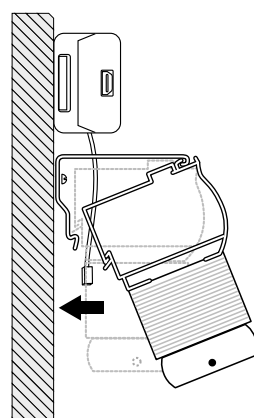

Outside Mount

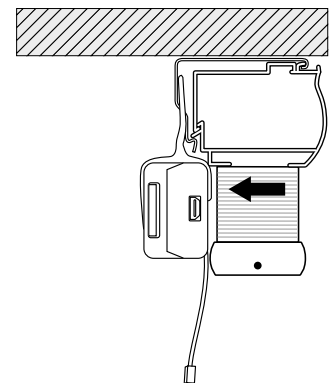

Inside Mount

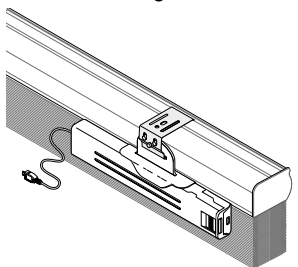

Cellular and Pleated
Battery Consideration

For Inside Mounts:

- The cleanest and simplest method available for cellular and pleated shades is the integrated battery pack hanger; this hanger attaches directly to a shade bracket to support the battery pack while allowing the case to be removed for battery changes; additional recessed space will be needed.

For Outside Mounts:

- For outside mounts, battery packs can be installed above or to the side of the shade.

Motorization Power Options

12-Volt Power Components

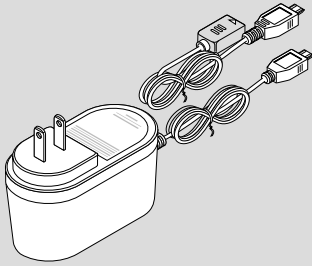

Plug-In Transformer

- Eliminates the need for batteries
- Small plug profile
- Cord can be concealed behind curtains or along trim
- 72" power cord and 96" extension cable (power cord and extensions cannot be cut to length)
- Can add one additional 48" (122.0 cm) or 96" (243.9 cm) motor-to-power extensions, 2 extensions per motor
- We recommend shades greater than 7,200 square inches utilize a transformer to eliminate changing batteries frequently
- Available in White only

Transformer Dimensions

- 3/4" wide x 2" deep (not including plug) x 1 1/2" tall (as you look at the plug in the outlet)
- Wire management components are not included with your motorized shade system



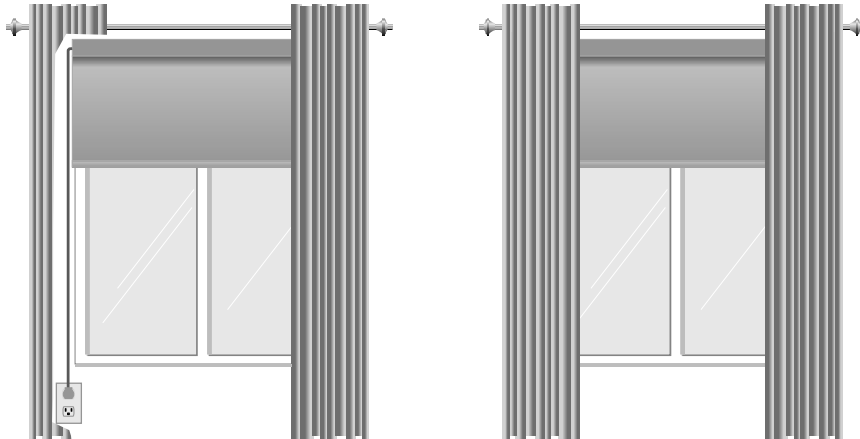

DC Plug-In Transformer Considerations

- A power outlet must be within cord length to power motor
- Transformer power available for shade systems of any size or quantity



NOTE: Due to the many variations of installations, wire management components are not included with your motorized shade system. There are numerous wire management products available at your local hardware store or home improvement center to help disguise the power cord when using a plug-in transformer. An example of a popular wire management accessory is wire channel. Wire channel is a vinyl sheathing that can be placed along the window casing or wall that will house and conceal exposed wiring for a clean and professional appearance.

Motorization Control Options

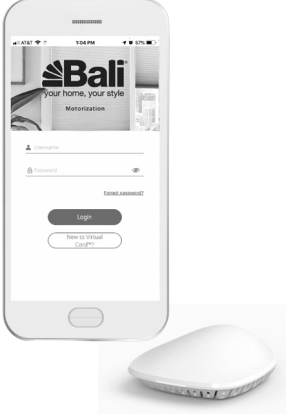
Motorization Controls	
	<p>Standard Remote (not available with sheer, layered, or cellular bottom-up/top-down shades)</p> <ul style="list-style-type: none"> • Used to control single shade • Includes convenient mounting hardware • Battery included—CR2430 • Available in White
	<p>Plus Remote (not available for cellular bottom-up/top-down)</p> <ul style="list-style-type: none"> • Single-channel control • Used to control single shades or a group of shades simultaneously • Set and use an intermediate position for your shades • Includes convenient mounting hardware • Battery included—CR2430 • Available in White
	<p>Plus Remote Decorator Wall Plate Kit (Plus remote sold separate)</p> <ul style="list-style-type: none"> • Provides attractive mounting option to match look of existing light switches • Locates the remote where most convenient for the user • Helps prevent misplacing of remote when not in use • Mounts flush to wall with included anchors, no cutting of drywall needed • Available in White only
	<p>Premium Remote (12-channel)</p> <ul style="list-style-type: none"> • 12-channel remote, controls up to 24 shades • Control single shades on each channel or group shade performing the same function • Shades are added to the remote from the manufacture. Channel assignment will need to be done at time of install. • Control Bottom Up, Top Down cellular shades • Convenient display provides easy programming • Set and use an intermediate position for your shades • Includes mounting wall plate and hardware; mounts to wall with anchors (see premium remote mounting options) • Batteries included—2 AAA • Available in White
	<p>Bali Motorization Gateway</p> <p>The Bali Motorization Gateway takes your motorized shades to the next level. The gateway allows you to control your shades away from your home, integrate with third party services, and schedule routines based on sunrise and sunset.</p> <ul style="list-style-type: none"> • Controls up to 20 devices (shade motors and remotes); only 1 gateway is required per house • Control single shades individually with the ability to group shades in rooms for additional functionality • Integrate directly with Amazon Alexa and Google Assistant for voice control • Create routines to control multiple shades with the ability to schedule based on sunrise and sunset • Compatible with Apple and Android devices • Requires a 2.4Ghz or 5GHz, password protected, Wi-Fi network • Multiple users can be added to an account with the option to assign different permission levels

For pricing, see Bluetooth and Z-Wave motorization controls pricing.

Remote Mounting Options

Standard Remote

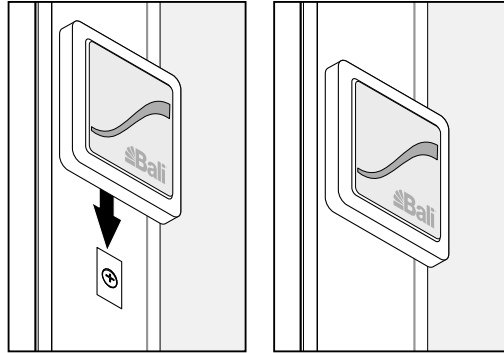

Standard Remote

Plus Remote Mounting Options

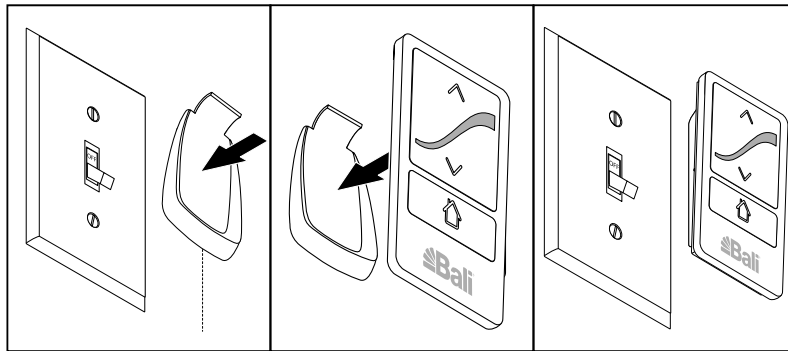

Plus Remote

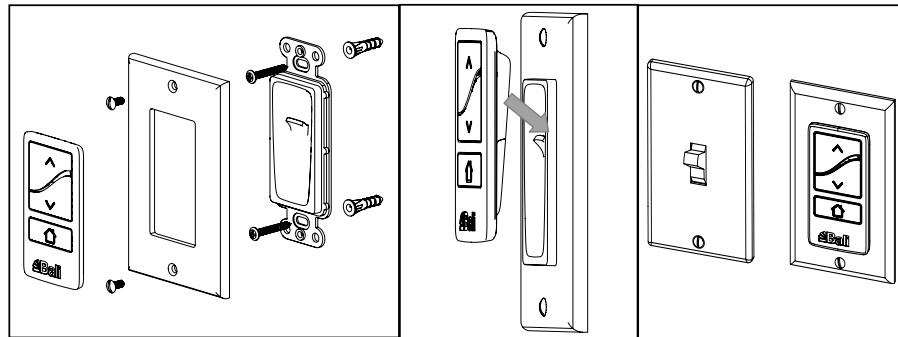

Optional Decorator Wall Plate Mount
(see Motorization Control options for details)

Premium Remote Mounting Options

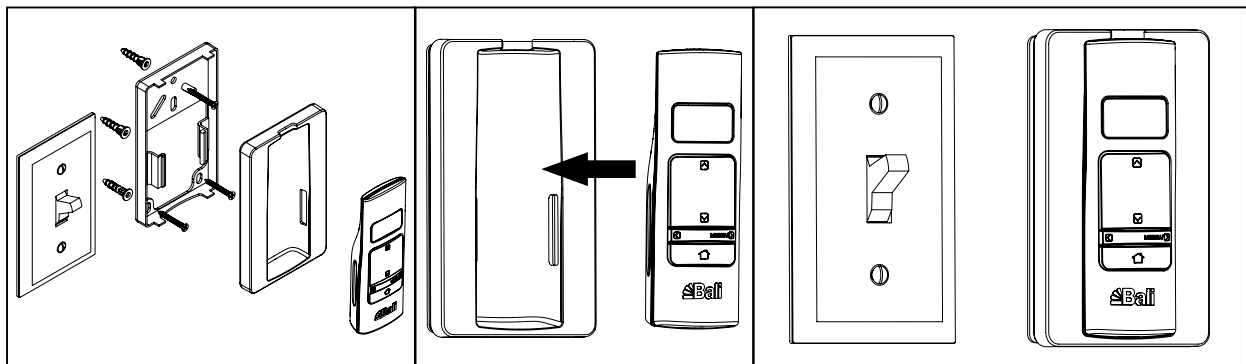

Premium Remote



Bali is a brand of Springs Window Fashions, the Best Experience Company

Bali and the Bali logo are registered trademarks of Springs Window Fashions, LLC.