

WOOD, COMPOSITE, AND FAUX WOOD BLINDS

Product Information Guide

Features

The Bali® Wood Story, Bali Wood Characteristics	2
Northern Heights™ Wood Blinds, Composite Blinds, Premium Faux Wood and Faux Wood Blinds	3

Size Considerations

Cordless Lift, Depth Requirements for Inside Mount.	4
---	---

Options

Blind Options, Cut-Out Blinds	5
Multiple Blinds on One Headrail, Control Lengths for Wands	6
Bay and Corner Windows.	7
Valance Options	8-9
How to Measure for Valance Returns, Order Valances, and Valance Keystones	10
Splicing Requirements, How to Measure a Special Splice Location.	11
Slat Count Table: 2" Wood Blinds	12
Slat Count Table: 2 ³ / ₈ " Wood Blinds	13
Slat Count Table: 2" Composite, Premium Faux Wood, and Faux Wood Blinds	14
Slat Count Table: 2 ¹ / ₂ " Composite, Premium Faux Wood, and Faux Wood Blinds	15
Slat Route and Ladder Count Charts: Northern Heights 2" and 2 ³ / ₈ " Wood Blinds, 2" and 2 ¹ / ₂ " Composite Blinds, 2" 2 ¹ / ₂ " Premium Faux Wood and Faux Wood Blinds,	16
Cordless Lift Blinds Product Detail: Wood, Composite, and Faux Wood	17

PLEASE NOTE:

Photos and illustrations are for inspiration only.
Not all product configurations are available in all countries.

Window blind cords are a strangulation hazard for young children. Consult your dealer or store associate for cordless products, or products with inaccessible cords. Remove this product immediately if a cord longer than 22 cm, or a loop exceeding 44 cm, becomes accessible.

VEUILLEZ NOTER :

Les photos et les illustrations ne sont offertes qu'à titre d'inspiration. Toutes les configurations de produits ne sont pas disponibles dans tous les pays.

Les cordons pour store de fenêtre représentent un risque d'étranglement pour les jeunes enfants. Consultez votre dépositaire ou un associé de magasin pour des produits sans cordon ou des produits dont les cordons ne sont pas accessibles.

Retirez ce produit immédiatement si un cordon mesurant plus de 22 cm de longueur ou une boucle dépassant 44 cm deviennent accessibles.



MAY 2024

Features

The Bali® Wood Story

With Bali Wood Blinds, you can be confident you are selecting a window treatment that is manufactured and finished with the highest commitment to quality and the environment.

- We own the facilities that produce and finish our wood blind components
- We control the quality of the manufacturing process, from green lumber through finished product
- We dry the wood slowly, molding and sanding it to strict specifications for a high quality surface
- We carefully sort wood for color uniformity and wood characteristics in our own state-of-the-art finishing facility
- We use only high quality paints and stains applied on-site, by certified color technicians
- We use a three-step finishing process to ensure the wood's stain is consistent and beautiful for the life of your blinds
- We practice sound forestry techniques—nearly twice as much hardwood grows as is harvested in the U.S.
- We preserve natural resources—wood-fired boilers consume recycled wood sawdust and shavings to generate the heat needed to dry our lumber

Bali Wood Characteristics

Wood used to manufacture Bali Wood Blinds has many natural characteristics that make it truly unique. The following are all natural characteristics of wood, and we do not consider them to be defects:

- Grain—The direction, size, and appearance of wood fibers vary greatly depending on where the wood is cut from within the tree
- Tiger Striping—Occurs when a tree develops wavy grain, due to genetics, soil content, or other natural scenarios
- Burl—Formed from an irregular growth on the outer edge of the tree
- Bird's Eye—Small area on the surface of the board where fibers are contorted to form circular figures that resemble birds' eyes
- Pin Knots—Vary in size, shape, structure, and color
- Mineral Marks—Dark or discolored areas caused by minerals which the tree extracts from the water or soil; can be either a streak or a stain, usually blackish blue
- Lodge/Rustic—Material contains markings that are more extreme than in standard products; the number and degree of marking will vary throughout the blind

Please be assured that these markings in no way affect the durability or the structural integrity of the blind.

Natural variations in color and grain are inherent in the beauty of wood. These variations are within established industry guidelines and should be expected. In addition, blinds may stain slightly darker or lighter than the swatches shown in the sampling.

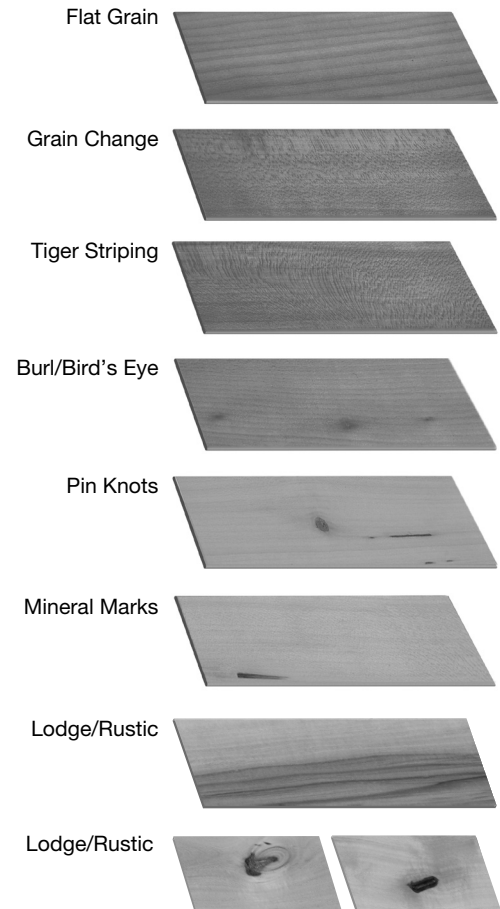

Features

Northern Heights™ Wood Blinds

- Stained and painted blinds crafted from North American hardwoods
- Finish highlights the natural characteristics of wood
- 2" and 2³/₈" slat sizes available
- Sandblast is not available on keystones
- Easy grip bottomrail for superior closure; makes lifting and lowering cordless lift blinds easier; standard on 2" and 2³/₈" cordless lift wood blinds

Composite Blinds

- Moisture-resistant multiple polymer composite slats
- 2" and 2¹/₂" slat sizes available
- Cordless lift option
- Trapezoid bottomrail for superior closure

Premium Faux Wood and Faux Wood Blinds

- Solid or woodgrain moisture-resistant engineered polymer slats
- 2" and 2¹/₂" slat sizes available in both premium faux wood and faux wood
- Trapezoid bottomrail for superior closure; available on premium faux wood blinds only

Size Considerations

Cordless Lift

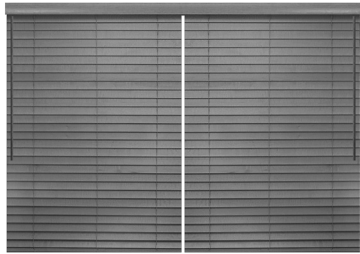
	 <p>Cordless Lift Blinds</p>				 <p>Cordless Lift Blinds Multiple Blinds on One Headrail</p>				
	Width		Height		Width			Height	
	Min (exact) (inches)	Max (inches)	Min (inches)	Max (inches)	Min Panel (exact) (inches)	Max Panel (inches)	Max Blind (inches)	Min Blind (inches)	Max Blind (inches)
Styles									

Northern Heights™ Wood Blinds

Northern Heights 2" Wood Blinds	12	84	12	86	12	84	120	12	96
Northern Heights 2" Distressed and Rustic Wood Blinds	12	84	12	86	12	84	120	12	96
Northern Heights 2½" Wood Blinds	12	84	12	86	12	84	120	12	96



Composite Blinds

2" Composite Blinds	12	84	12	86	12	84	120	12	96
2½" Composite Blinds	12	84	12	86	12	84	120	12	96

Premium Faux Wood and Faux Wood Blinds

2" Premium Faux Wood Blinds	12	84	12	86	12	84	120	12	96
2" Faux Wood Blinds	12	84	12	86	12	84	120	12	96
2½" Premium Faux Wood Blinds	12	84	12	86	12	84	120	12	96
2½" Faux Wood Blinds	12	84	12	86	12	84	120	12	96

Depth Requirements for Inside Mount

		 <p>Partially recessed headrail in window casing/molding</p>	 <p>Fully recessed headrail in window casing/molding</p>
		Minimum Depth Mount (inches)	Flush with Casing (without valance)*
Blind Type	Headrail Dimensions (inches)	Wand Tilt (inches)	
Northern Heights 2" and 2½" Wood Blinds	2 x 2¼	¾	2¾
2" and 2½" Composite Blinds	2 x 2¼	¾	2¾
2" and 2½" Premium Faux Wood and Faux Wood Blinds	2 x 2¼	¾	2¾

*For measurements of fully recessed headrails with a valance, see valance options.

Options

Blind Options (for surcharges and pricing refer to price charts)

Blind Options	Northern Heights 2" Wood	Northern Heights 2 3/8" Wood	2" and 2 1/2" Composite	2" Premium Faux Wood and 2" Faux Wood	2 1/2" Premium Faux Wood and 2 1/2" Faux Wood	Details
Bay and Corner Windows	•	•	•	•	•	See the "Options" section for measuring and ordering information
Control Locations						
• Tilt Left	•	•	•	•	•	Must be requested at time of order
• Tilt Right	•	•	•	•	•	
Cut-Outs	• [§]	• [§]	• [§]	• [§]	• [§]	See the "Options" section
Hold Down Brackets	•	•	•	•	•	Must be requested at time of order
Multiple Blinds on One Headrail: 2 or 3 on 1 to left of solid line*	• [§]	• [§]	• [§]	• [§]	• [§]	See the "Options" section
Projection Brackets						Projection brackets not available for inside mount; must be requested at time of order; shims are standard on 2 3/8" and 2 1/2" blinds (outside mount)
• 2 3/4" and 4 3/4" Projection Brackets	•	•	•	•	•	
• 3/16" Shims	•	•	•	•	•	
Wand Tilt	•	•	•	•	•	Color coordinated
Wood Cornices	• [§]	• [§]	• [§]	• [§]	• [§]	See cornices and valances product information guide

*See solid line on appropriate price grid.

+3/8" projection block available.

§Option available with surcharge.

^Not available with 2 1/2" composite.

Cut-Out Blinds

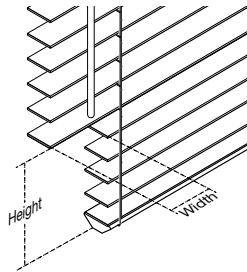

- **For surcharge, see price charts**
- Maximum cut-out is 1" before route hole (corner and side cut-outs only)
- Cut-outs are measured with the slats tilted in the closed position for maximum clearance
- The cut-out height may be larger than requested due to slat placement
- Measure height from the bottom of the window up to the desired location
- Not available with wood vertical blinds
- Blinds will be tilt only, no lift

NOTE: Standard lead time does not apply for this feature. Additional manufacturing time is required.

Options

Multiple Blinds on One Headrail



Gap 1/4"

- **Surcharge:** blinds to the left of the solid line on the price charts
- **No charge:** blinds to the right of the solid line on the price charts
- Two or more blinds can be installed on a single headrail to provide a practical treatment for larger windows or sliding patio doors
- Due to weight limitations, some blinds must be manufactured as two or three blinds on one headrail

Multiple Blinds	Control Locations	Gap (inches)
Cordless Lift		
Two-on-One Headrail	Left panel (tilt left) Right panel (tilt right)	1/4
Three-on-One Headrail	Left panel (tilt left) Right panel (tilt right) Center panel (tilt left)	1/4

NOTE: Optional control locations may be requested.

Measuring

1. Measure overall width of the area to be covered. If space permits, an overlap of 1 1/2" per side is recommended for outside mounts.
2. Measure the width of the area each blind is to cover. Measure and specify the left blind first, continuing to the right. Allow a minimum of 1/4" between blinds for operating clearance.
3. Total width of all blinds, plus clearance(s), must equal overall width.
4. Measure height as follows:
 - a. For windows, use standard inside or outside measuring procedures.
 - b. For patio doors, measure height within 3/4" of floor, either from ceiling or a point at least 6 1/2" above the door frame. Check slat count table to see if blind will completely clear the doorway.

Ordering

1. Indicate whether two or three blinds are to be mounted on one headrail.
2. Specify total width of headrail.
3. Indicate each panel width separately, specify left blind first, continuing to the right.
4. Specify tilt position.
5. Add appropriate surcharge, if to the left of the solid line on the price chart.

Control Lengths for Wands

Finished Blind Height (inches)	Wand Length* (inches)
up to 36	12
36 7/8 to 60	20
60 7/8 to 70	30
70 7/8 to 80	40
80 7/8 to 90	48

*Wands over 48" long are a clear plastic.

NOTE: Special length wands may be requested at the time of ordering.

Options

Bay and Corner Windows

- Made as individual blinds to fit in bay or corner windows
 - Each blind is on an individual headrail and has its own control
 - Indicate each blind with bypass or butt; bypass is the blind mounted into the corner; butt is the blind butted up to the other blind; must provide blind location (left and right blind)
 - Tilt locations can be on the right or left side of each blind; placing tilter opposite the corner is recommended
 - Depending on the angle, some corner blinds cannot be raised to the same height
 - Manufacturer will take appropriate deductions for proper fit
 - No additional charge
 - Valances will be mitered in the corner for finished look
 - Cornices and wood verticals are not available on bay or corner windows
 - Slat alignment cannot be guaranteed on side by side blinds
 - If you do not want manufacturer to take deductions DO NOT order as bay or corner
- NOTE:** Standard lead time does not apply for this feature. Additional manufacturing time is required.

Measuring Information

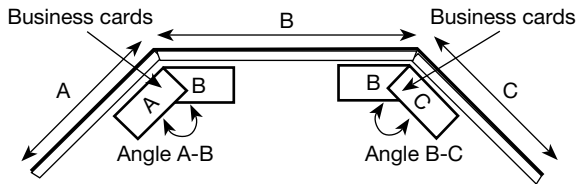
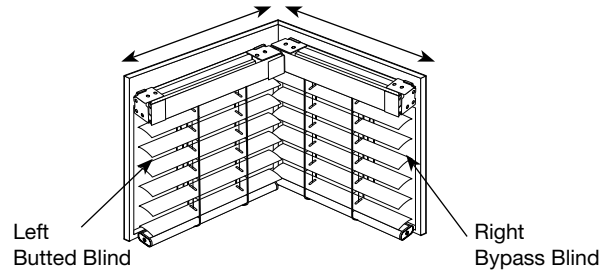
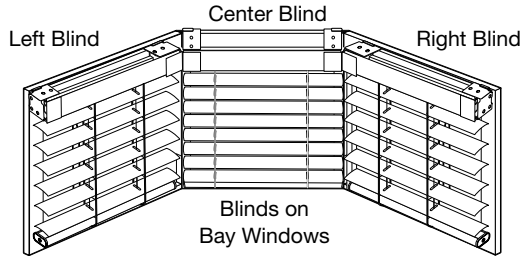

Corner Window

Measure:
Width of each window from corner to the point you would like to cover.

Three-Sided Bay Window

Measure:
A and C: Width of side windows from the corners to the point you would like the blind to cover.
B: Width of the center window from corner to corner.
Angle A—B: Angle between windows (A) and (B).
Angle B—C: Angle between windows (B) and (C).

Four-Sided Bay Window

Measure:
A and D: Width of side windows from the corners to the point you would like the blind to cover.
B and C: Width of each window from corner to corner.
Angle A-B: Angle between windows (A) and (B).
Angle B-C: Angle between windows (B) and (C).
Angle C-D: Angle between windows (C) and (D).

Five-Sided Bay Window

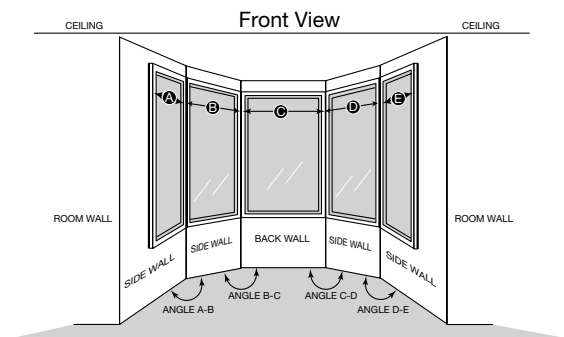
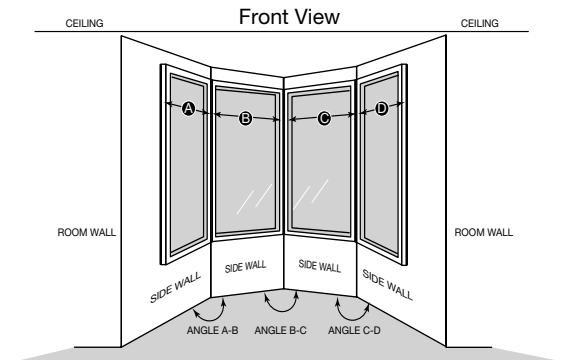

Measure:
A and E: Width of side windows from the corners to the point you would like the blind to cover.
B, C, and D: Width of each center window from corner to corner.
Angle A-B: Angle between windows (A) and (B).
Angle B-C: Angle between windows (B) and (C).
Angle C-D: Angle between windows (C) and (D).
Angle D-E: Angle between windows (D) and (E).

NOTE: Measure bay angle using protractor or angle finder, or use two business cards in bay corner as illustrated above, trace onto paper and fax to customer service.



Options

Valance Options

Valance Type	Blind Type	Maximum Continuous Width*		Standard Valance Returns (inches)	Full Recess Depth (inches)	
		Inside Mount No Returns (inches)	Inside Mount with Returns (inches)			
3" Standard Valance  Valance Returns 1/2" to 1": glued 1 1/16" to 4 3/8": optional glued 4 11/16" and greater: not glued	2" Wood	100 1/4	98 3/8	2 7/8 3 3/16 3 3/8 2 3/4	3 1/4 3 7/8 3 3/4 3 1/16	
	2 3/8" Wood	100 1/4	98 3/8	3 3/4 3 3/4 3 3/16 3 3/16	4 1/16 4 1/16 3 19/16 3 19/16	
	2" Composite^	106 5/8	105 3/8	2 7/8 3 3/16 3 3/8 2 3/4	3 1/4 3 7/8 3 3/4 3 1/16	
	2 1/2" Composite^	106 5/8	105 3/8	3 15/16 3 15/16 3 3/4 3 3/4	4 1/4 4 1/4 4 1/8 4 1/8	
	2" Premium Faux Wood^ 2" Faux Wood^	106 5/8	105 3/8	2 7/8 3 3/16 3 3/8 2 3/4	3 1/4 3 7/8 3 3/4 3 1/16	
	2 1/2" Premium Faux Wood^ 2 1/2" Faux Wood^	106 5/8	105 3/8	3 15/16 3 15/16 3 3/4 3 3/4	4 1/4 4 1/4 4 1/8 4 1/8	
	3 3/4" Eloquence Valance  Valance Returns 1/2" to 1": glued 1 1/16" to 4 3/8": optional glued 4 11/16" and greater: not glued	2" Composite^	106 5/8	105 3/8	2 7/8 3 3/16 3 3/8 2 3/4	3 3/8 4 1/16 3 7/8 3 3/16
		2 1/2" Composite^	106 5/8	105 3/8	3 15/16 3 15/16 3 3/4 3 3/4	4 7/16 4 7/16 4 1/4 4 1/4
		2" Premium Faux Wood^ 2" Faux Wood^	106 5/8	105 3/8	2 7/8 3 3/16 3 3/8 2 3/4	3 3/8 4 1/16 3 7/8 3 3/16
		2 1/2" Premium Faux Wood^ 2 1/2" Faux Wood^	106 5/8	105 3/8	3 15/16 3 15/16 3 3/4 3 3/4	4 7/16 4 7/16 4 1/4 4 1/4

*Continuous valances wider than sizes shown above will have two or more sections spliced together with a keystone.



Maximum width for spliced valances is 300 3/4".

^Keystones not available.

NOTE: For replacement valances see cornices and valances product information guide.

Options

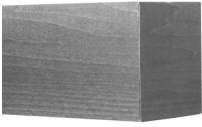
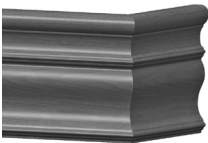
Valance Options

Valance Type	Blind Type	Maximum Continuous Width*		Standard Valance Returns (inches)	Full Recess Depth (inches)
		Inside Mount No Returns (inches)	Inside Mount with Returns (inches)		
3½" Modern Valance  Valance Returns ½" to 1": glued 1⅙" to 4⅞": optional glued 4⅙" and greater: not glued	2" Wood	100¼	98⅝	2⅞ 3⅞ 3⅞ 2¼	3¼ 3⅞ 3¼ 3⅙
	2⅝" Wood	100¼	98⅝	3¼ 3⅞ 3⅞	4⅙ 4⅙ 3⅙
3½" Premium Traditional Valance  Valance Returns ½" to 1": glued 1⅙" to 4⅞": optional glued 4⅙" and greater: not glued	2" Wood	100¼	98⅝	2⅞ 3⅞ 3⅞ 2¼	3½ 4⅙ 4 3⅞
	2" Distressed Wood [^]	100¼	98⅝	2⅞ 3⅞ 3⅞ 2¼	3½ 4⅙ 4 3⅞
	2⅝" Wood	100¼	98⅝	3¼ 3⅞ 3⅞	4⅞ 4⅙ 4⅙
4½" Eloquence Valance  Valance Returns ½" to 1": glued 1⅙" to 4⅞": optional glued 4⅙" and greater: not glued	2" Wood	100¼	98⅝	2⅞ 3⅞ 3⅞ 2¼	3⅞ 4⅙ 4⅞ 3½
	2⅝" Wood	100¼	98⅝	3¼ 3⅞ 3⅞	4½ 4½ 4⅙ 4⅙

*Continuous valances wider than sizes shown above will have two or more sections spliced together with a keystone. Maximum width for spliced valances is 300¾".

[^]Keystones not available.

NOTE: For replacement valances see cornices and valances product information guide.

Options

How to Measure for Valance Returns

Window depths vary considerably depending on the age and style of the window. **Always** measure the window depth, regardless of the type of window treatment the client is considering. Knowing the depth when the order is placed can help prevent costly errors.

To calculate the return width, use this formula:

[standard return width] minus [client window depth] = special return width to order for inside mount blind

REMEMBER:

- Smallest return width is ½" (inside measurement), maximum return width is 8"
- Returns ½" to 1" (inside measurement) will be glued; returns 1 1/16" to 4 5/8" (inside measurement) have the option of being glued
- The width of a return and the width of a valance are measured on the inside (back side) of the valance, not the outside (face) of the valance (see diagram at right)
- Standard return size for 2 3/8" blinds—subtract 3/16" prior to determining special return width
- Standard return size for 2 1/2" blinds—subtract 3/8" prior to determining special return width

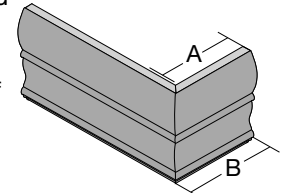

A: Inside Measurement
B: Outside Measurement

How to Measure and Order Valances

If a valance is ordered, it is supplied in one of the following styles, depending on how your blind will be mounted. For a more custom look, the valance and returns may be special ordered to your measurements.

NOTE: Valances with returns are measured and cut from the **INSIDE** of the miter to ensure the most accurate fit when installed over the headrail or window frame.

Blinds ordered as an OUTSIDE MOUNT with requested returns will be supplied with returns sized to cover the end of the blind back to the mounting surface. If projection brackets are requested when the blind is ordered, longer returns will be sent automatically. Outside mount blinds are available without returns upon request.

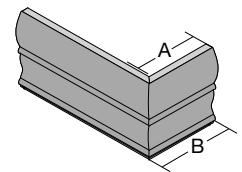
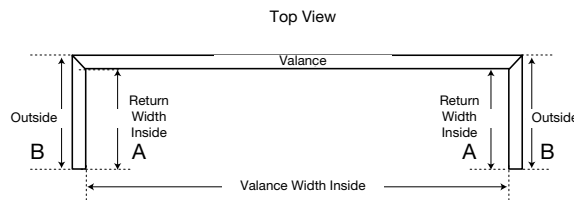

A: Inside Measurement
B: Outside Measurement

NOTE: Minimum return width is ½", maximum return width is 8".

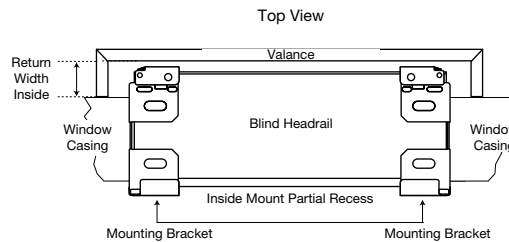

Additional Ordering Information:

- Please state at the time of order if the valance and return measurements are for the **EXACT** size required so that no additions or deductions are made
- Different return sizes can be ordered for the same valance; always provide **LEFT** return **INSIDE** measurement first when ordering
- Returns ½" to 1" (inside measurement) will be glued; returns 1 1/16" to 4 5/8" (inside measurement) have the option of being glued; returns 4 1/16" (inside measurement) and greater will not be glued
- Bay and corner blinds—must specify return width on inside mount at time of order
- Single side returns are available—opposite end will be cut straight

Valance Keystones

- Decorative keystones are required on wood valances that require splicing
- Keystones will be equally spaced unless special splice locations are requested at time of order
- Optional keystones can be ordered with single piece valances, or in addition to required keystones at the time of order only
 - Minimum width with a keystone: 12"
 - Maximum number of keystones: 3
- Keystones will be stained or painted to match the valance ordered as standard; optional different color selection available
- Keystones not available on distressed wood, in sandblast finish, composite, or faux wood valances
- Keystones cannot be ordered for existing valances, attachment will not work
- All inside mount applications will have a slight light gap at the top of valance when installed

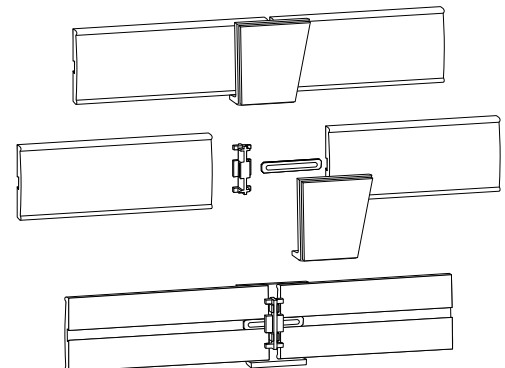

Options

Splicing Requirements

Profile	Number of Sections	Number of Keystones	No Returns		With Returns (inside dimensions)	
			Minimum (inches)	Maximum (inches)	Minimum (inches)	Maximum (inches)
3" Standard Wood Valance	1	0	8	100 ¹ / ₄	8	98 ³ / ₈
3 ¹ / ₂ " Modern Wood Valance	2	1	100 ¹ / ₁₆	200 ¹ / ₂	98 ⁷ / ₁₆	198 ⁵ / ₈
3 ¹ / ₂ " Premium Traditional Wood Valance						
4 ¹ / ₂ " Eloquence Wood Valance	3	2	200 ¹ / ₁₆	300 ³ / ₄	198 ¹¹ / ₁₆	298 ⁷ / ₈

Outside Mount

- Wood valances requiring a splice will include a keystone (see chart above for details)

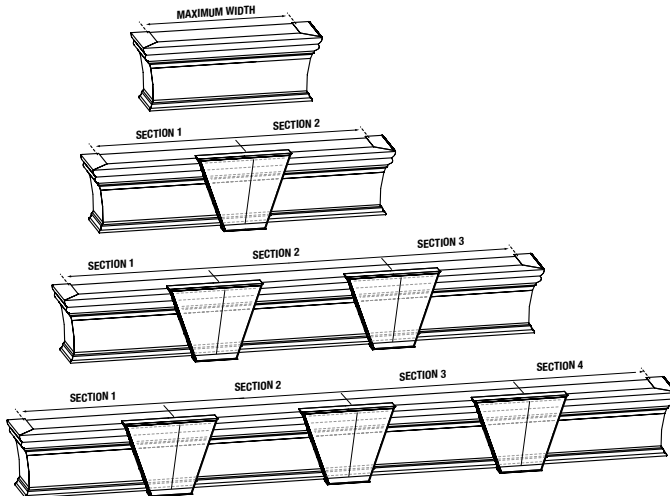

Inside Mount

- Wood valances 100¹/₄" or wider will require a keystone

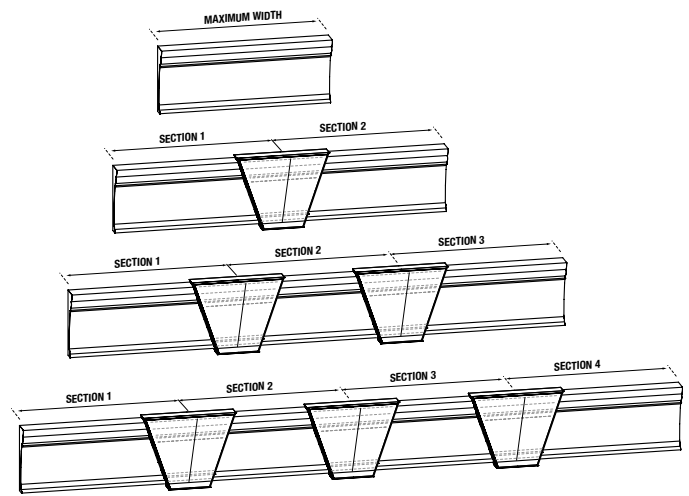

How to Measure a Special Splice Location

A keystone is supplied for valance widths that require a splice. Keystone locations will be equally spaced unless a special splice location is requested at time of order. The placement of the splice will be calculated by the factory using an **INSIDE** measurement from the mitered corner to the location specified on the order.

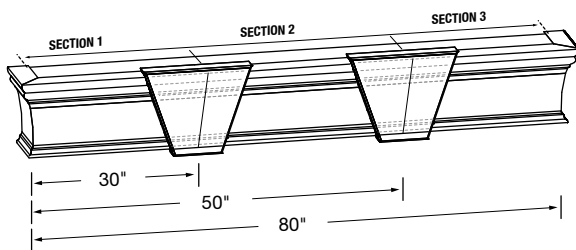

Each splice location should be recorded starting from the **LEFT BACKSIDE** corner.

These formulas are used to calculate BACKSIDE valance measurements.

Inside Mount with No Returns	Ordered width - ¹ / ₁₆ "
Inside Mount with Returns	Ordered width + ¹ / ₄ "
Outside Mount with No Returns	Ordered width + ¹ / ₂ "
Outside Mount with Returns	Ordered width + ³ / ₄ "

Example: Overall valance width = 80" backside measurement
 First splice from left = 30" backside measurement
 Second splice from left = 50" backside measurement

For surcharge, see price charts.

NOTE: All measurements need to be from BACKSIDE.

General Information

Slat Count Table: 2" Wood Blinds

Number of Slats	2" Wood Blinds	
	Finished Blind Height (inches)	Finished Stack Height (inches)
7	12	4 ⁵ / ₈
8	14 ⁵ / ₁₆	
9	16 ¹ / ₁₆	
10	17 ¹³ / ₁₆	5 ³ / ₈
11	19 ⁹ / ₁₆	
12	21 ¹ / ₄	
13	23	
14	24 ³ / ₄	
15	26 ⁷ / ₁₆	
16	28 ³ / ₁₆	
17	29 ¹⁹ / ₁₆	
18	31 ¹¹ / ₁₆	
19	33 ³ / ₈	
20	35 ⁵ / ₈	7
21	36 ⁷ / ₈	
22	38 ⁹ / ₁₆	
23	40 ⁵ / ₁₆	
24	42 ¹ / ₁₆	
25	43 ¹³ / ₁₆	
26	45 ¹ / ₂	
27	47 ¹ / ₄	
28	49	
29	50 ¹ / ₁₆	
30	52 ¹ / ₁₆	8 ³ / ₁₆
31	54 ³ / ₁₆	
32	55 ¹⁵ / ₁₆	
33	57 ³ / ₈	
34	59 ³ / ₈	
35	61 ¹ / ₈	
36	62 ¹³ / ₁₆	
37	64 ⁹ / ₁₆	
38	66 ⁵ / ₁₆	

Number of Slats	2" Wood Blinds	
	Finished Blind Height (inches)	Finished Stack Height (inches)
39	68 ¹ / ₁₆	
40	69 ³ / ₄	10 ⁵ / ₈
41	71 ¹ / ₂	
42	73 ³ / ₄	
43	74 ¹⁵ / ₁₆	
44	76 ¹ / ₁₆	
45	78 ⁷ / ₁₆	
46	80 ⁹ / ₁₆	
47	81 ¹ / ₈	
48	83 ³ / ₈	11 ¹ / ₁₆
49	85 ³ / ₈	
50	86	
51		
52		
53		
54		
55		
56		
57		
58		
59		
60		
61		
62		
63		
64		
65		
66		
67		
68		
69		
70		

NOTE: Finished height includes headrail and bottomrail.

General Information

Slat Count Table: 2³/₈" Wood Blinds

Number of Slats	2 ³ / ₈ " Wood Blinds		Number of Slats	2 ³ / ₈ " Wood Blinds	
	Finished Blind Height (inches)	Finished Stack Height (inches)		Finished Blind Height (inches)	Finished Stack Height (inches)
6	12	4 ¹⁵ / ₁₆	32	67 ³ / ₄	
7	14 ⁵ / ₈		33	69 ⁵ / ₈	
8	16 ³ / ₄		34	72	
9	18 ¹ / ₂		35	74 ¹ / ₂	
10	21	5 ⁹ / ₁₆	36	76 ¹ / ₄	
11	23 ¹ / ₈		37	78 ³ / ₈	
12	25 ¹ / ₄		38	80 ¹ / ₂	
13	27 ³ / ₈		39	82 ³ / ₈	
14	29 ¹ / ₂		40	84 ³ / ₄	10 ⁵ / ₁₆
15	31 ³ / ₈		41	86	
16	33 ³ / ₄		42		
17	35 ⁵ / ₈		43		
18	38		44		
19	40 ¹ / ₂		45		
20	42 ¹ / ₄	7 ¹ / ₈	46		
21	44 ³ / ₈		47		
22	46 ¹ / ₂		48		
23	48 ³ / ₈		49		
24	50 ³ / ₄		50		
25	52 ³ / ₈		51		
26	55		52		
27	57 ¹ / ₈		53		
28	59 ¹ / ₄		54		
29	61 ³ / ₈		55		
30	63 ¹ / ₂	8 ³ / ₄	56		
31	65 ⁵ / ₈		57		

NOTE: Finished height includes headrail and bottomrail.

General Information

Slat Count Table: 2" Composite, Premium Faux Wood, and Faux Wood Blinds

Number of Slats	2" Composite, Premium Faux Wood, and Faux Wood Blinds		Number of Slats	2" Composite, Premium Faux Wood, and Faux Wood Blinds	
	Finished Blind Height (inches)	Finished Stack Height (inches)		Finished Blind Height (inches)	Finished Stack Height (inches)
5	12	4 ⁹ / ₁₆	37	66 ⁹ / ₁₆	
6	12 ⁵ / ₈		38	68 ¹ / ₁₆	
7	14 ³ / ₁₆		39	69 ³ / ₄	
8	16 ¹ / ₁₆		40	71 ¹ / ₂	10 ¹ / ₈
9	17 ¹³ / ₁₆		41	72	
10	19 ⁹ / ₁₆	5 ³ / ₈	42		
11	21 ¹ / ₄		43		
12	23		44		
13	24 ³ / ₄		45		
14	26 ⁷ / ₁₆		46		
15	28 ³ / ₁₆		47		
16	29 ¹⁵ / ₁₆		48		
17	31 ¹¹ / ₁₆		49		
18	33 ³ / ₈		50		
19	35 ⁵ / ₈		51		
20	36 ⁷ / ₈	7	52		
21	38 ¹ / ₁₆		53		
22	40 ⁵ / ₁₆		54		
23	42 ¹ / ₁₆		55		
24	43 ¹³ / ₁₆		56		
25	45 ¹ / ₂		57		
26	47 ¹ / ₄		58		
27	49		59		
28	50 ¹¹ / ₁₆		60		
29	52 ⁷ / ₁₆		61		
30	54 ³ / ₁₆	8 ⁹ / ₁₆	62		
31	55 ¹⁵ / ₁₆		63		
32	57 ³ / ₈		64		
33	59 ³ / ₈		65		
34	61 ¹ / ₈		66		
35	62 ¹³ / ₁₆		67		
36	64 ¹ / ₁₆		68		

NOTE: Finished height includes headrail and bottomrail.

General Information

Slat Count Table: 2½" Composite, Premium Faux Wood, and Faux Wood Blinds

Number of Slats	2½" Composite, Premium Faux Wood, and Faux Wood Blinds	
	Finished Blind Height (inches)	Finished Stack Height (inches)
5	12	4¾
6	14¾	
7	16¾	
8	18¾	
9	21	
10	23¾	5⅞
11	25¾	
12	27¾	
13	29½	
14	31¾	
15	33¾	
16	35¾	
17	38	
18	40¾	
19	42¼	
20	44¾	7⅞
21	46½	
22	48¾	
23	50¾	
24	52¾	
25	55	
26	57¾	
27	59¼	
28	61¾	
29	63½	
30	65¾	8¾

Number of Slats	2½" Composite, Premium Faux Wood, and Faux Wood Blinds	
	Finished Blind Height (inches)	Finished Stack Height (inches)
31	67¾	
32	69¾	
33	72	
34		
35		
36		
37		
38		
39		
40		
41		
42		
43		
44		
45		
46		
47		
48		
49		
50		
51		
52		
53		
54		
55		

NOTE: Finished height includes headrail and bottomrail.

General Information

Slat Route and Ladder Count Charts

Take any inside mount deductions before determining ladder quantity (inside mount— $\frac{1}{2}$ "; outside mount—no deduction).

Blinds with two lift cords will have two clear plastic cord stop beads located approximately 2" below the headrail. Cords will continue down, each ending in a tassel. Blinds with three or more lift cords will have the cords joined together with a tassel approximately 2" below the headrail. Two individual cords will continue down, each ending in a tassel.

2" and 2½" Composite Blinds

For Standard or Reverse Controls

Finished Blind Width (inches)	Slat End Route (inches)	# of Ladders	# of Lifts	# of Center Brackets
12 to 22	4	2	2	0
22½ to 38	5	3	3	0
38½ to 52	5	4	4	1 over 48" FBW
52½ to 66	5	5	5	1

NOTES:

1. Maximum spacing between ladders is 14".
2. Standard control positions: tilt left; tilt right is optional.
3. Maximum slat width is 66". Wider blinds must be multiple blinds on one headrail.

2" and 2½" Premium Faux Wood and Faux Wood Blinds

For Standard or Reverse Controls

Finished Blind Width (inches)	Slat End Route (inches)	# of Ladders	# of Lifts	# of Center Brackets
12 to 19	4	2	2	0
19½ to 30	4	3	2	0
30½ to 41	4	4	4	0
41½ to 52	4	5	3	1 over 48" FBW
52½ to 63	4	6	6	1

NOTES:

1. Maximum spacing between ladders is 11".
2. Standard control positions: tilt left; tilt right is optional.
3. Maximum slat width is 63". Wider blinds must be multiple blinds on one headrail.

Northern Heights 2" and 2¾" Wood Blinds

For Standard or Reverse Controls

Finished Blind Width (inches)	Slat End Route (inches)	# of Ladders	# of Lifts	# of Center Brackets
12 to 24	4	2	2	0
24½ to 36½	6½	2	2	0
36¾ to 50	6½	3	2	1 over 48" FBW
50½ to 60	6½	3	3	1
60¾ to 84	6½	4	4	2 over 72" FBW

NOTES:

1. Maximum spacing between ladders is 23½".
2. Standard control positions: tilt left; tilt right is optional.
3. Maximum slat width is 84". Wider blinds must be multiple blinds on one headrail.

General Information

Cordless Lift Blinds Product Detail: Wood, Composite, and Faux Wood

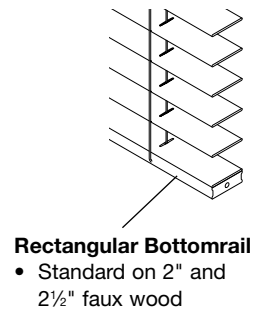
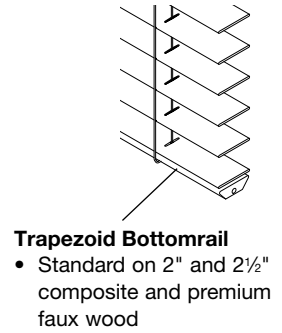
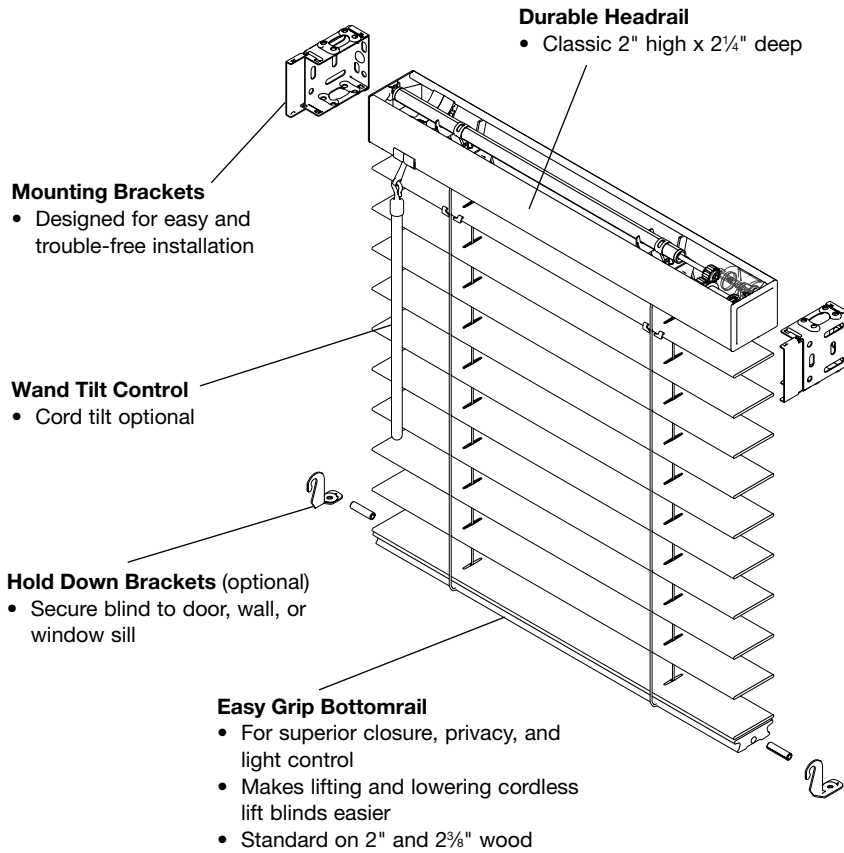

Pair cordless lift with wand tilt for a blind that eliminates operating cords and is safer for homes with children and pets, or pair it with cord tilt for fast, simple control.

To lower blind, simply pull down on the bottomrail. To raise the blind, simply guide the blind into the desired location by gently lifting the bottomrail.

Not available with sky pole option.

Slat Comparison

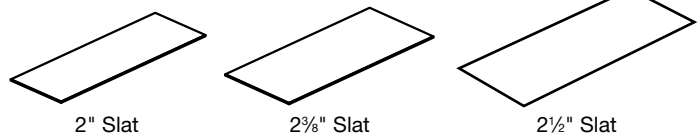



Bali is a brand of Springs Window Fashions, the Best Experience Company

Bali and the Bali logo are registered trademarks of Springs Window Fashions, LLC.

(05/24) 24-454900